

# Portfolio

2015



**eks** 

fiber optic systems

## eks Engel ...

... **schafft Kommunikation** – Lichtwellenleitertechnik sorgt auch über weite Entfernungen, unter Extrembedingungen und in technisch höchst anspruchsvollen Bereichen für erstklassige Kommunikation und Datenübertragung. Unsere Elektroniksysteme und Kommunikationsbausteine arbeiten zuverlässig und präzise. Flexibilität inklusive.

... **überzeugt durch Kompetenz** – als mittelständische Hightechschmiede stehen wir ein für gutes Handwerk in bester Symbiose mit Tradition, Fortschritt und innovativem Know-how. Durch LWL-Erfahrung und intelligente Dienstleistungen bieten wir unseren Kunden erstklassige Qualität und passgenaue Lösungen. Seit mehr als zwei Jahrzehnten.

... **bietet mehr als Standards** – wir veredeln Standards und entwickeln produkt- und anwendungsspezifische Sonderlösungen die perfekt auf die Anforderungen unserer Kunden zugeschnitten sind – gerne ab Stückzahl 1. Unsere leistungsfähigen Standardlösungen sind nach DIN EN ISO 9001 zertifiziert. Unsere Spleißboxen, konfektionierten Kabel und Verteilerkästen global im Einsatz.



## eks Engel

... **connects people** – fiber optic technology ensures a safe data transmission across long distances even under extreme conditions. Our devices and communication systems are highly reliable and precise. Flexibility included.

... **convinces with expertise** – as a medium sized company, we offer the perfect synthesis of excellent craftsmanship, venerable tradition and progressive advancement. Our fiber optic expertise has been ensuring first class quality and customized solutions for more than 20 years.

... **offers more than standards** – we refine and enhance standard offerings and develop product specific solutions that clearly set themselves apart from the competition. The experience and quality awareness of our company has been rewarded with the DIN EN ISO 9001 certificate.



... **findet Lösungen** – ob Audio, Video, Telefon – eks-Lichtwellenleitertechnik ermöglicht eine durchgängige, rasante Datenübertragung. So lassen sich Anlagen optimal schützen, Daten sicher und schnell übertragen, Prozesse reibungsfrei steuern. Höchste Zuverlässigkeit garantiert.

... **zeigt Präsenz** – als LWL-Marktführer bieten wir das Quäntchen mehr: mehr Know-how, mehr Innovation, mehr Kundennähe. Egal ob auf internationalen Messen, bei Fachtagungen, im Internet, in Social Media-Netzwerken oder bei Kundenbesuchen – Offenheit, Hilfsbereitschaft und Freundlichkeit sind für unser junges Team selbstverständlich. Ob auf Deutsch, Englisch, Spanisch, Türkisch...



... **ein erfolgreicher südwestfälischer Mittelständler** – „Made in Germany“, das ist eins unserer Erfolgsargumente im globalen Markt. Als zuverlässiger Partner unserer Kunden stellen wir uns neuen Herausforderungen und bilden unsere Fachkräfte aktiv aus und weiter. eks Engel ist Preisträger beim „Großen Preis des Mittelstandes“ der Oskar Patzelt-Stiftung 2010! – Auf diesen Titel sind wir stolz.



... **finds solutions** – whether audio, video or telephone: eks systems allow high speed data transmission. Thus your application is perfectly safe, all processes can be controlled easily – high reliability included.

... **demonstrates presence** – as a leading fiber optic manufacturer we offer a bit more: more knowhow, more innovation, more customer focus. Whether international trade fairs, symposia, social networks or business calls: cooperativeness, friendliness and candidness are self-evident for us in many languages: German, English, Spanish, Turkish...



... **is a successful medium sized company** – “Made in Germany” is one of our sales arguments on the global market. As a reliable partner for our customers we face new challenges every day and train our own specialists and offer them to study further. Our innovations and customer service earned us the award of the Oskar Patzelt Foundation, Germany’s most prestigious honor for medium-sized companies.

# Produkte, Entwicklung und Projektierung

Für unsere Kunden entwickeln, produzieren und vertreiben wir Standard- sowie anwendungsspezifische LWL-Systeme und -Komponenten zur Anbindung herstellereigener Systeme.

Die kompetente Planungsunterstützung des eks-Fiber Optic Supports von Projektbeginn bis zur Realisierung rundet das Angebot „LWL aus einer Hand“ ab.

## Individuelle Anpassungen

Gemeinsam mit Ihnen schaffen wir Lösungen für Sie. Kundenspezifische Applikationen umfassen:

- Erstellung eines Pflichtenheftes
- Mechanische Anpassungen
- Elektronische Neuentwicklung oder Modifikation
- Dokumentation

und werden termin- und leistungsgerecht ausgeführt.



## Products, development and project planning

Besides the well-established standard systems and services, eks also offers customized special solutions for industrial partners. Our well-trained construction team offers expert support from the early planning up to the final installation of the systems. In this context, eks uses its longtime expertise and the multifaceted applications of the fiber optic components, which are developed and produced at the eks headquarter since 1987.

### Customizing

Together we create solutions. Customized applications consist of:

- creation of functional specification
- mechanical adjustments
- electronic development or modification
- documentation

and are delivered according to performance and time schedule.

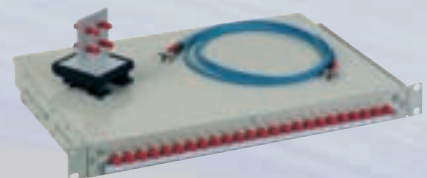

<b>Bypass</b>	<b>XL-Optical Bypass</b>	Optical Bypass for more security	6
<b>Ethernet</b>	<b>EL100-XS</b>	Media Converter	8
	<b>EL100-3U /-3UP</b>	Media Converter / PoE-Media Converter	10
	<b>EL1000-3G</b>	Gigabit Media Converter	12
	<b>EL100-4U</b>	8-Port Ethernet Switch unmanaged / Essential Line	14
	<b>EL100-X</b>	4-Port Ethernet Switch unmanaged	16
	<b>EL100-2U</b>	6-/7-/8-Port Ethernet Switch unmanaged	18
	<b>EL1000-2G</b>	Gigabit 7-Port Ethernet Switch unmanaged	20
	<b>EL100-2M</b>	8-Port Ethernet Switch managed	22
	<b>EL100-2MA</b>	8-Port Ethernet Switch with ProfiNet managed	24
<b>Interface</b>	<b>DL485 /485-4W</b>	RS485 Fiber Optic System / RS485 Four-Wire Fiber Optic System	26
	<b>DL485-MBR</b>	MODBUS Fiber Optic System redundant	28
	<b>DL485-PB</b>	PROFIBUS Fiber Optic System	30
	<b>DL485-PBR</b>	PROFIBUS Fiber Optic System redundant	32
	<b>DL485-MBP</b>	MODBUS-PLUS Fiber Optic System	32
	<b>DL485-MBPR</b>	MODBUS-PLUS Fiber Optic System redundant	34
	<b>DLCAN</b>	CAN Fiber Optic System	34
	<b>DLCAN-R</b>	CAN Fiber Optic System redundant	36
	<b>DL422</b>	RS422 Fiber Optic System	36
	<b>DL232</b>	RS232 Fiber Optic System	38
	<b>DL232-R</b>	RS232 Fiber Optic System redundant	40
	<b>DL232-MUX</b>	4xRS232 Multiplexer Fiber Optic System	40
	<b>DLTTY</b>	TTY Fiber Optic System	42
	<b>DLLWW</b>	Media Converter	44
<b>Analog/Digital</b>	<b>IOL3000</b>	4 x Analog + 8 x Digital Fiber Optic System	46
	<b>IOL3100</b>	4 x Digital Fiber Optic System	48
	<b>IOL3200</b>	12 x Digital Fiber Optic System	50
	<b>IOL3300</b>	1 x Digital Fiber Optic System	52
<b>DragonLine</b>	<b>Switch</b>	5x10/1000TX / 8x10/1000TX	54
	<b>Switch</b>	4x10/100/1000TX+1xSFP	55
	<b>Switch</b>	7x10/100TX + COMBO: 3x10/100/1000T + 3xSFP, managed	56
	<b>Switch</b>	16x10/100TX + COMBO: 2x10/100/1000T + 2xSFP, managed	58
	<b>PoE Switch</b>	4x10/100TX PoE + 1x10/100TX	60
	<b>VDSL2-Extender</b>	Ethernet - VDSL2 Extender	61
<b>Passives</b>	<b>FIMP</b>	Splicebox for up to 12 Fibers	62
	<b>FIMP-S</b>	Splicebox for up to 12 Fibers	64
	<b>FIMP-XL</b>	Splicebox for up to 24 Fibers	66
	<b>FIMP-XL Hybrid</b>	Splicebox for up to 12 Fibers and 6xRJ45 CAT6	68
	<b>RACK 19</b>	19"-Rack with DIN Rail Mounting	70

Technische Änderungen vorbehalten!

Subject to modifications!

© eks Engel GmbH & Co. KG / Ver. 03/2015

# XL-Optischer Bypass

## Optischer Bypass für mehr Sicherheit

x-light ermöglicht die sichere Kommunikation auch bei Ausfall oder Störung eines Netzwerkteilnehmers, indem er diesen optisch überbrückt und dadurch den Datenverkehr permanent gewährleistet. x-light ist hersteller- und protokollunabhängig und integriert sich somit optimal in jedes Netzwerk, egal ob Linien- oder Ringstruktur. x-light wird aktiviert, wenn eine einstellbare Auslösespannung unterschritten wird. Zudem kann das System über den Signaleingang flexibel angesteuert werden, z.B. im Service- oder Fehlerfall.

Die Serie umfasst Systeme, die mit Multimode- oder Singlemode-LWL funktionieren. Weitere Leistungsmerkmale sind ein erweiterter Temperaturbereich, redundante Spannungsversorgung, eine Kostenreduzierung durch Wegfall zusätzlicher USVs sowie die Reduzierung der Wartungskosten.

Das Edelstahlgehäuse bietet größtmögliche Flexibilität und Sicherheit bei allen Anwendungen im Innen- und Außenbereich. Die Montage kann sowohl auf der Hutschiene, als auch auf der Wand erfolgen.

## Optical bypass for more security

x-light ensures a safe communication even in case of device failure by optically bypassing the defective node so that a permanent data transmission is guaranteed. x-light is manufacturer and protocol independent so that it perfectly integrates into every network, regardless of the structure (ring or line). x-light is activated once the voltage is lower than the adjusted voltage level. Furthermore, the system can be controlled flexibly via the trigger input, e.g. in case of service or failures.

x-light provides highest availability in multi- or singlemode fiber optic networks. Additional features are a high temperature range, a redundant power supply, a cost effective solution because it needs no additional UPS (uninterrupted power supply) and it reduces service costs.

The stainless steel housing offers an extremely high degree of flexibility and safety for all kinds of indoor and outdoor applications. It can either be mounted onto a DIN EN rail or fastened onto the wall.

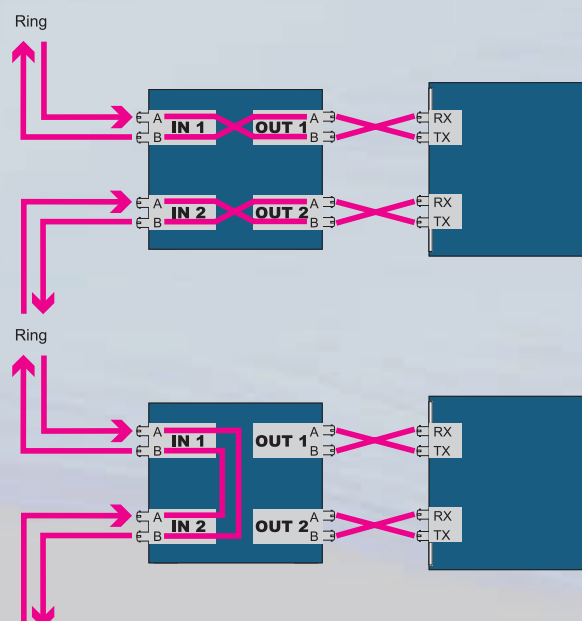

Type	50/125-MM-ST	50/125-MM-SC	50/125-MM-LC	62,5/125-MM-ST	62,5/125-MM-SC	62,5/125-MM-LC	9/125-SM-ST	9/125-SM-SC	9/125-SM-LC
Order No.	0 1500 5021	0 1500 5023	0 1500 5024	0 1500 6221	0 1500 6223	0 1500 6224	0 1500 0931	0 1500 0933	0 1500 0934
Fiber-connector	ST	SC	LC	ST	SC	LC	ST	SC	LC
Fiber	Multi-Mode 50/125µm			Multi-Mode 62,5/125µm			Single-Mode 9/125µm		
Wavelength	850nm (±40nm) 1310nm (±40nm)						1310nm (±40nm) 1550nm (±40nm)		
Insertion Loss	≤ 1,4dB *						≤ 1,7dB *		
Durability switch	10 million cycles								
Switching speed	15ms max. / 4ms typ. / 4ms in a temperature range between +5°C and +70°C								
Type	Non latching								
Switch-on delay	5s, 10s, 20s and/or 40s switchable by DIP-switch								
Threshold level	1V, 2V, 4V, 8V, 16V and/or 32V between 10V and 64V switchable by DIP-switch								
Connector	4-pin: Power supply / 4-pin: Failure relay and signal input								
Control - LEDs	Power supply (green) / Ready (green)								
Operating voltage	10VDC - 64VDC								
Power consumption	2,5 W								
Failure relay contact	25VDC (1A) / 60VDC (0,3A)								
Operating temperature	-40°C - +70°C								
EMC	EN61000-6-2 (2001) / EN55022 Kl. B (1998) +A1 + A2								
Weight	500 g								
Dimensions H x D x W	115mm x 61mm x 113mm								
Housing	Stainless steel, powder-coated								

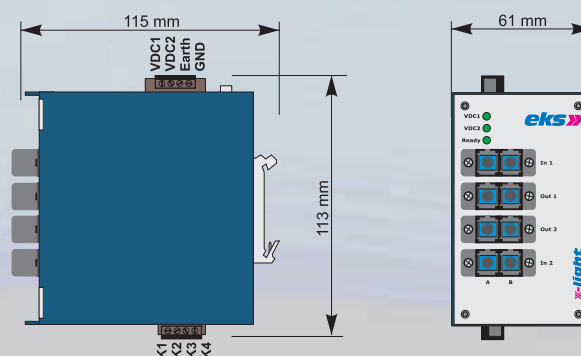

# EL100-XS

## Kompakter Medienkonverter unmanaged

Die Serie EL100-XS umfasst unmanaged Medienkonverter für 10/100MBit/s, die mit Kunststoff-, HCS-, Multimode- oder Singlemode-LWL funktionieren. Weitere Leistungsmerkmale sind Auto-Negotiation, MDX/MDIX und ein erweiterter Temperaturbereich.

Das flache Design des Edelstahlgehäuses bietet größtmögliche Flexibilität und Sicherheit bei allen Anwendungen im Innen- und Außenbereich. Die Montage kann sowohl auf der Hutschiene, als auch auf der Wand erfolgen. Im Lieferumfang ist der Clip bereits enthalten. Eingesetzt werden kann der EL100-XS überall dort, wo enge Platzverhältnisse herrschen, wie z.B. im Kleinverteilergehäuse.

In Verbindung mit den anderen Systemen der Baureihen e-light bzw. DragonLine lassen sich somit individuelle Applikationen realisieren.

Zudem gibt eine Systemvariante zum Einbau in den PC, die eine Alternative zu Netzwerkkarten mit Glasfaseranschluss darstellt. Diese ermöglicht eine LWL-Anbindung des PCs ohne Modifikation im Betriebssystem. Da viele PCs keine separaten Netzwerkkarten mehr haben, sondern über auf dem Mainboard fest installierte Netzwerkanschlüsse verfügen, empfiehlt sich das System als preiswerte Lösung, selbst wenn kein PCI-Steckplatz mehr frei oder vorhanden ist. Die Stromversorgung erfolgt aus dem PC heraus über das im Lieferumfang befindliche Kabel, so dass nur noch der Netzwerkausgang des PC's mit dem System über ein Netzwerkkabel verbunden werden muss.

## Mini-Media Converter unmanaged

The series EL100-XS contains unmanaged media converters which operate with POF, HCS-, multimode or singlemode fiber optic. Additional features are autonegotiation, MDX/MDIX and extended temperature range.

The flat design of the stainless steel housing offers an extremely high degree of flexibility and safety for all kinds of indoor and outdoor applications. EL100-XS can either be mounted onto a DIN EN rail or fastened onto the wall. A clip is already included in the scope of delivery. EL100-XS is suitable wherever there is little space, e.g. in small distribution boxes.

In connection with other systems out of the e-light and DragonLine series respectively, individual applications can be realized.

Apart from that there is a version for the installation in PCs – a perfect alternative for network interface cards with fiber optic connectors. This card allows connecting fiber optics without any modification in the operation system. Since many PCs do not have a separate network interface card anymore, but network jacks on the mainboard, e-light PC is a low cost solution even if no PCI slot is available any more. A cable (included in the scope of delivery) can be used to power the device from the power supply of the PC so that you only have to connect the network interface card of the PC and the media converter with a network cable.





Type	1TX-1FX- PO-ST	1TX-1FX- PO-SMA	1TX-1FX- MM-ST	1TX-1FX- MM-SC	1TX-1FX- MM-SC/ BIDIA(B)	1TX-1FX- SM-ST	1TX-1FX- SM-SC	1TX-1FX- SM-E2	1TX-1FX- SM-SC/ BIDIA(B)
Order no. EL100-XS/	0 4200 01 01E	0 4200 01 02E	0 4200 01 31E	0 4200 01 33E	0 4200 01 36E (BIDIA) 0 4200 01 37E (BIDIB)	0 4200 01 51E	0 4200 01 53E	0 4200 01 55E	0 4200 01 56E (BIDIA) 0 4200 01 77E (BIDIB)
FO connector	ST	SMA	ST	SC	SC	ST	SC	E-2000	SC
Fiber	POF or HCS (980/1000 μm) (200/230 μm)		Multimode 62,5 (50) /125 μm			Singlemode 9/125 μm			
Optical budget	12 dB		12 dB	15 dB		16 dB			
FO range	50 m or 120 m (180dB/km) (10dB/km)		up to 5 km (1 dB/km)			30 km, others up to 100 km on request (0,3 dB/km)			
Wavelength	650 nm or 850 nm		1310 nm	1310 nm 1550 nm		1310 nm			1310 nm 1550 nm
Status - LEDs	Link/Act per port								
Operating voltage	12-24 VDC / 2,5W								
Operating temperature	-40°C - +70°C (Multimode and Singlemode with ST or SC) -20°C - +55°C (all others)								
Storage temperature	-40°C - +85°C								
EMC	EN61000-6-2 / EN55022 +A1 + A2 Class A								
Weight	200 g								
Dimensions H x W x D	H: 25 mm W: 62 mm D: 80 mm								
Housing	Stainless steel, powder coated								

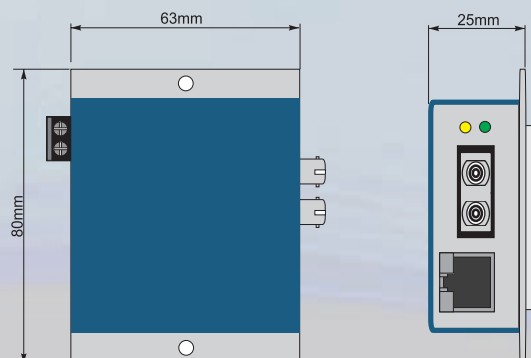

# EL100-3U / EL100-3UP

## Medienkonverter / PoE-Medienkonverter, unmanaged

Die Medienkonverter der Serie EL100-3U und EL100-3UP (mit PoE-Funktion) haben eine ultrakompakte Bauform mit den Abmaßen von 82 x 93 x 22,5 mm. Sie zeichnen sich durch einfache Funktionalität und Bedienfreundlichkeit wie Auto-Negotiation und Auto MDX/MDIX aus.

Das flache Design des Gehäuses bietet größtmögliche Flexibilität und Sicherheit bei allen Anwendungen im Innen- und Außenbereich. Eingesetzt werden kann der EL100-3U / EL100-3UP überall dort, wo enge Platzverhältnisse herrschen, wie z.B. in Kleinverteilergehäusen. In Verbindung mit den anderen Systemen der Baureihen e-light bzw. DragonLine lassen sich somit individuelle Applikationen realisieren.

In der Standardversion funktioniert der EL100-3U im Modus Converter Mode, wenn alle Ports auf 100MBit/s arbeiten, ansonsten arbeitet das System in einem Cut-Through-Modus. Auf Wunsch kann das System auch mit dem Modus Store & Forward angeboten werden. **Für besonders geringe Latenzzeiten kann das Gerät im Pass-Through Modus geliefert werden.**

## Media Converter / PoE-Media Converter, unmanaged

The EL100-3U and EL100-3UP (with PoE-function) media converters have an extra small housing with a dimension of 82 x 93 x 22,5 mm. Its features are Auto-Negotiation and Auto MDX/MDIX.

The flat design of the housing offers an extremely high degree of flexibility for all kinds of indoor and outdoor applications. EL100-3U / EL100-3UP is suitable wherever there is little space, e.g. in small distribution boxes. In connection with other systems out of the e-light and DragonLine series respectively, individual applications can be realized.

The EL100-3U / EL100-3UP standard mode is Converter Mode, if all ports work with 100MBit/s. Otherwise the mode is Cut-Through. **Optionally, the device is also available with Store & Forward mode or with Pass-Through mode if a small latency is needed.**



Type	1TX-1FX- POF-ST	1TX-1FX- POF-SMA	1TX-1FX - MM-ST	1TX-1FX - MM-SC	1TX-1FX - MM-SC/ BIDIA(B)	1TX-1FX - SM-ST	1TX-1FX - SM-SC	1TX-1FX - SM-E2	1TX-1FX - SM-SC/ BIDIA(B)
Order no. EL100-3U/	0 4500 01 01E	0 4500 01 02E	0 4500 01 31E	0 4500 01 33E	0 4500 01 36E (BIDIA) 0 4500 01 37E (BIDIB)	0 4500 01 51E	0 4500 01 53E	0 4500 01 55E	0 4500 01 56E (BIDIA) 0 4500 01 77E (BIDIB)
Order no. EL100-3UP/ (Alternative A)	0 4600 01 01E	0 4600 01 02E	0 4600 01 31E	0 4600 01 33E	0 4600 01 36E (BIDIA) 0 4600 01 37E (BIDIB)	0 4600 01 51E	0 4600 01 53E	0 4600 01 55E	0 4600 01 56E (BIDIA) 0 4600 01 77E (BIDIB)
Alternative B on request									
FO connector	ST	SMA	ST	SC	SC	ST	SC	E-2000	SC
Fiber	POF or HCS (980/1000 µm) (200/230 µm)		Multimode 62,5 (50) /125 µm			Singlemode 9/125 µm			
Optical budget	12 dB		12 dB	15 dB	16 dB				
FO range	50 m or 120 m (180dB/km) (10dB/km)		up to 5 km (1 dB/km)			30 km, others up to 100 km on request (0,3 dB/km)			
Wavelength	650 nm or 850 nm		1310 nm	1310 nm 1550 nm	1310 nm			1310 nm 1550 nm	
Status - LEDs	TX data per port / PoE-Status (EL-100 U3P)								
Operating voltage					EL100-3U	12 - 65 VDC			
					EL100-3UP	<b>PoE:</b> 44 - 57 VDC			
						<b>PoE+:</b> 50 – 57 VDC			
Power consumption					EL100-3U	2,4 W, 100 mA (24V)			
					EL100 3UP	2,4 W, 50 mA (48V) + PoE			
Operating temperature	-10°C - +55°C								
PoE Power (Alternative A)					<b>PoE</b>	15,4W (IEEE 802.3af)			
					<b>PoE+</b>	up to 40 W (IEEE 802.3at)			
EMC	EN61000-6-2 / EN55022 +A1 + A2 Class A								
Weight	150 g								
Dimensions H x W x D	H: 82 mm W: 93 mm D: 22,5 mm								
Housing	Polyamide, black								

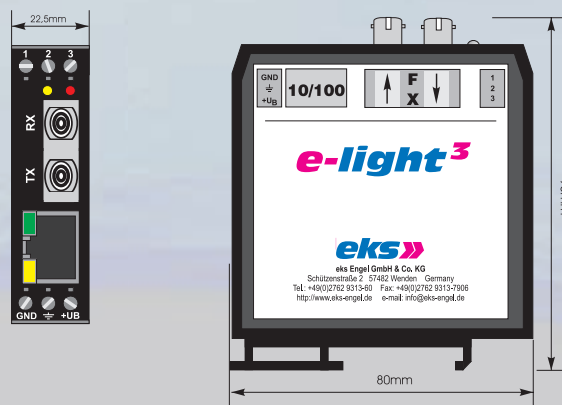

# EL1000-3G

## Gigabit Medienkonverter, unmanaged

Die Medienkonverter der Serie EL1000-3G haben eine ultrakompakte Bauform mit den Abmaßen von 82 x 93 x 22,5 mm. Sie zeichnen sich durch einfache Funktionalität und Bedienfreundlichkeit wie Auto-Negotiation und Auto MDX/MDIX aus.

Das flache Design des Gehäuses bietet größtmögliche Flexibilität und Sicherheit bei allen Anwendungen im Innen- und Außenbereich. Eingesetzt werden kann der EL1000-3G überall dort, wo enge Platzverhältnisse herrschen, wie z.B. in Kleinverteilergehäusen. In Verbindung mit den anderen Systemen der Baureihen EL1000-2G bzw. DragonLine lassen sich somit individuelle Applikationen realisieren.

Der EL1000-3G funktioniert im Modus Store & Forward.

## Gigabit Media Converter, unmanaged

The EL1000-3G media converters have an extra small housing with a dimension of 82 x 93 x 22,5 mm. Its features are Auto-Negotiation and Auto MDX/MDIX.

The flat design of the housing offers an extremely high degree of flexibility for all kinds of indoor and outdoor applications. EL1000-3G is suitable wherever there is little space, e.g. in small distribution boxes. In connection with other systems out of the EL1000-2G and DragonLine series respectively, individual applications can be realized.

The EL1000-3G standard mode is Store & Forward.



Type				1TX-1FX - MM-SC			1TX-1FX - SM-SC	1TX-1FX - SM-E2	
Order no. EL1000-3GU/				0 4500 10 33			0 4500 10 53	0 4500 10 55	
FO connector				SC			SC	E-2000	
Fiber				Multimode 62,5 (50) /125 µm			Singlemode 9/125 µm		
Optical budget				7,5 dB			11,5 dB		
FO range				up to 550m (1 dB/km)			10 km, others up to 100 km on request (0,3 dB/km)		
Wavelength				850 nm			1310 nm		
Status - LEDs	TX data per port								
Operating voltage	12 - 65 VDC								
Power consumption	2,4 W, 100 mA (24V)								
Operating temperature	-10°C - +55°C								
Jumbo frames	Option / Please request								
EMC	EN61000-6-2 / EN55022 +A1 + A2 Class A								
Weight	150 g								
Dimensions H x W x D	H: 82 mm W: 93 mm D: 22,5 mm								
Housing	Polyamide, black								

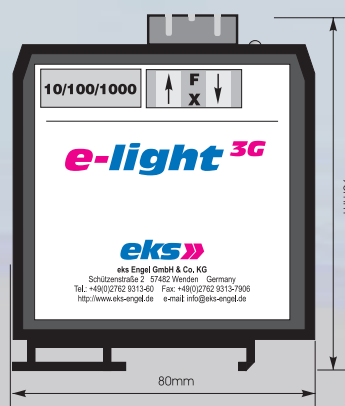

# EL100-4U

## 5 - und 8-Port Switch, unmanaged

Die Serie EL100-4U „Essential Line“ umfasst fünf industriegerechte Basic-Switches, die Fast Ethernet unterstützen. Da diese Switches lediglich drei Zentimeter breit sind, benötigen sie nur wenig Platz. Bei extrem flachen Einbauräumen kann der Hutschienenclip an der Seite der Geräte montiert werden. Für die Installation in 19“-Racks ist eine Blende verfügbar. Neben einem Switch mit fünf oder acht Twisted Pair-Ports (10/100 BASE-TX) werden vier Ausführungen mit zusätzlichen optischen Schnittstellen (100 BASE-FX) angeboten, die in den Kombinationen 8TX/2FX, 4TX/2FX, 4TX/1FX und 4TX/3FX bereitstehen. Die Schnittstellen sind entweder für Single-, Multimode- und HCS-Fasern erhältlich oder für POF. So lassen sich Entfernungen von bis zu 30 Kilometern überbrücken. Weitere Features sind Auto-Negotiation, MDX/MDIX und ein erweiterter Temperaturbereich. Die redundante Spannungsversorgung ist für 12 bis 70 VDC ausgelegt. Ihr Status wird ebenso wie der Status der Netzwerkverbindung über LEDs auf der Frontplatte angezeigt.

In Verbindung mit den anderen Systemen der Baureihen e-light bzw. DragonLine lassen sich somit individuelle Applikationen realisieren.

## 5- and 8-Port Switch, unmanaged

The EL100-4U series „Essential Line“ comprises five industrial basic switches for Fast Ethernet. Since they are only 3cm in width they do not need much space. In case of extremely flat installation space the DIN rail clip can be fixed at the side. Apart from that, they can be used in 19" racks by using an additional cover at the front.

The following switches are available: 5TX, 8TX, 8TX/2FX, 4TX/2FX, 4TX/1FX and 4TX/3FX. They can be used with singlemode, multimode, HCS and POF fibers. All switches are suitable for distances of up to 30 km. Other features are auto negotiation, MDX/MDIX and an extended temperature range. The redundant power supply is 12 to 70 VDC and its status - as well as the network status - can be seen from the LEDs on the front panel.

In connection with other systems out of the e-light and DragonLine series respectively, individual applications can be realized.



Type ST EL100 4U/	5TX	8TX	4TX-1FX- MM-ST	4TX-2FX- MM-ST	4TX-3FX- MM-ST	4TX-4FX- MM-ST	8TX-2FX- MM-ST	4TX-1FX- SM-ST	4TX-2FX- SM-ST	4TX-3FX- SM-ST	4TX-4FX- SM-ST	8TX-2FX- SM-ST
Order no.	0 5005 01 00 00 00- EV00-00	0 5008 01 00 00 00- EV00-00	0 5004 01 00 00 31- EV00-00	0 5004 01 00 31 31- EV00-00	0 5004 01 31 31 31- EV00-00	0 5004 01 31313131- EV00-00	0 5008 01 00 31 31- EV00-00	0 5004 01 00 00 51- EV00-00	0 5004 01 00 51 51- EV00-00	0 5004 01 51 51 51- EV00-00	0 5004 01 51515151- EV00-00	0 5008 01 00 51 51- EV00-00
Type SC EL100 4U/			4TX-1FX- MM-SC	4TX-2FX- MM-SC	4TX-3FX- MM-SC	4TX-4FX- MM-SC	8TX-2FX- MM-SC	4TX-1FX- SM-SC	4TX-2FX- SM-SC	4TX-3FX- SM-SC	4TX-4FX- SM-SC	8TX-2FX- SM-SC
Order no.			0 5004 01 00 00 33- EV00-00	0 5004 01 00 33 33- EV00-00	0 5004 01 33 33 33- EV00-00	0 5004 01 33333333- EV00-00	0 5008 01 00 33 33- EV00-00	0 5004 01 00 00 53- EV00-00	0 5004 01 00 53 53- EV00-00	0 5004 01 53 53 53- EV00-00	0 5004 01 53535353- EV00-00	0 5008 01 00 53 53- EV00-00
Type E2000 EL100 4U/			4TX-1FX- MM-E2	4TX-2FX- MM-E2	4TX-3FX- MM-E2	4TX-4FX- MM-E2	8TX-2FX- MM-E2	4TX-1FX- SM-E2	4TX-2FX- SM-E2	4TX-3FX- SM-E2	4TX-4FX- SM-E2	8TX-2FX- SM-E2
Order no.			0 5004 01 00 00 35- EV00-00	0 5004 01 00 35 35- EV00-00	0 5004 01 35 35 35- EV00-00	0 5004 01 35353535- EV00-00	0 5008 01 00 35 35- EV00-00	0 5004 01 00 00 55- EV00-00	0 5004 01 00 55 55- EV00-00	0 5004 01 55 55 55- EV00-00	0 5004 01 55555555- EV00-00	0 5008 01 00 55 55- EV00-00
Type SFP EL100 4U/						4TX-4FX SFP					4TX-4FX SFP	
Order no.						0 5004 01 99999999- EV00-00					0 5004 01 99999999- EV00-00	
Fiber	Multimode 62,5 (50) /125µm						Singlemode 9/125µm					
Optical budget	12 dB						16 dB					
FO range	up to 5 km (1 dB/km)						30 km, others up to 100 km on request (0,3 dB/km)					
Wavelength	1310 nm											
Status - LEDs	System fault (red) / Port LEDs (yellow/green) / Power supply (green)											
Power consumption	5 W, 200 mA (24 VDC)											
Operating voltage	12-60 VDC redundant power supply, other voltages on request											
Potential separation	500 V											
Operating temperature	-40°C - +70°C (Multimode and Singlemode with ST or SC) -20°C - +55°C (all others)											
Storage temperature	-40°C - +85°C											
EMC	EN61000-6-2 / EN55022 +A1 + A2 Class A											
Failure relay (optional)	25VDC (1A) / 60VDC (0,3A)											
Weight	500 g											
Dimensions H x W x D	5TX: : 130 x 25 x 105mm All others : 155 x 30 x 110mm (without transceiver)											
Housing	Steel, powder coated											
19" Mounting Brackets	Art.-No. 0500E90001 (Steel, powder coated)											

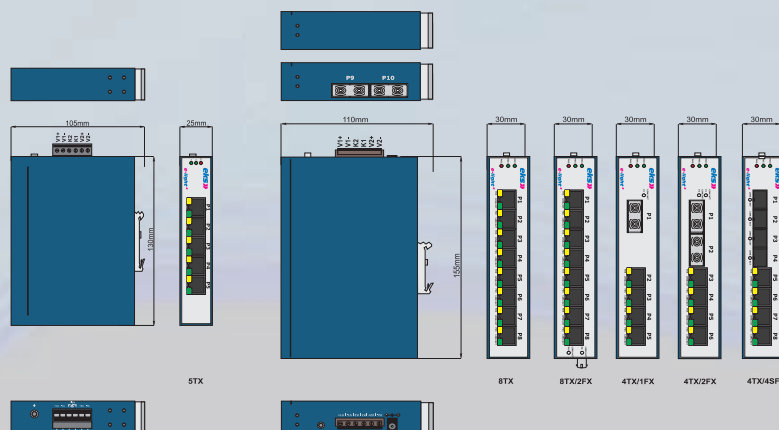

# EL100-X

## 4-Port Switch, unmanaged

Die Serie EL100-X umfasst unmanaged 4-Port-Switches für 10/100MBit/s mit wahlweise bis zu vier RJ45-Ethernet-Ports und bis zu zwei optischen Ports, die mit Kunststoff-, HCS-, Multimode- oder Single-mode-LWL funktionieren. Weitere Features sind Auto-Negotiation, MDX/MDIX, redundante Spannungsversorgung und ein erweiterter Temperaturbereich. LEDs und optional potenzialfreie Kontakte eines Fehlerrelais signalisieren fehlerhafte Zustände.

In Verbindung mit den anderen Systemen der Baureihen e-light bzw. DragonLine lassen sich somit individuelle Applikationen realisieren.

## 4-Port Switch, unmanaged

The series EL100-X contains unmanaged 4-Port-switches for 10/100MBit/s with optionally up to four RJ45-Ethernet-Ports and up to two optical ports which operate with POF, HCS-, multimode or singlemode fiber optic. Additional features are autonegotiation, MDX/ MDIX, redundant power supply and extended temperature range. LEDs and potential-free contacts (optional) of a fault detector relay are able to signal defective states.

In connection with other systems out of the e-light and DragonLine series respectively, individual applications can be realized.





<b>Type ST</b> EL100-X/	4TX	3TX-1FX-MM-ST	2TX-2FX-MM-ST		3TX-1FX-SM-ST	2TX-2FX-SM-ST			
Order no.	0 4800 01 0000	0 4800 01 0031	0 4800 01 3131		0 4800 01 0051-L	0 4800 01 5151-L			
<b>Type SC</b> EL100 X/		3TX-1FX-MM-SC	2TX-2FX-MM-SC		3TX-1FX-SM-SC	2TX-2FX-SM-SC	3TX-1FX-SM-SC-BIDI-A	3TX-1FX-SM-SC-BIDI-B	2TX-2FX-SM-SC-BIDI
Order no.		0 4800 01 0033	0 4800 01 3333		0 4800 01 0053-L	0 4800 01 5353-L	0 4800 01 0056 BIDI A	0 4800 01 0077 BIDI B	0 4800 01 5677 BIDI
<b>Type E2000</b> EL100 X/		3TX-1FX-MM-E2	2TX-2FX-MM-E2		3TX-1FX-SM-E2	2TX-2FX-SM-E2			
Order no.		0 4800 01 0035	0 4800 01 3535		0 4800 01 0055-L	0 4800 01 5555-L			
<b>Fiber</b>	Multimode 62,5 (50) /125µm			Singlemode 9/125µm					
<b>Optical Budget</b>	12 dB			16 dB					
<b>FO range</b>	up to 5 km (1 dB/km)			30 km, others up to 100 km on request (0,3 dB/km)					
<b>Wavelength</b>	1310 nm (BIDI: 1310 nm / 1550 nm)								
<b>Status - LEDs</b>	System fault (red) / Port LEDs (yellow/green) / Power supply (green)								
<b>Operating voltage</b>	12-30 VDC (other voltages on request)								
<b>Power consumption</b>	5 W, 200 mA (24V)								
<b>Potential separation</b>	500 V								
<b>Operating temperature</b>	-40°C - +70°C (Multimode and Singlemode with ST or SC) -20°C - +55°C (all others)								
<b>Storage temperature</b>	-40°C - +85°C								
<b>EMC</b>	EN61000-6-2 / EN55022 +A1 + A2 Class B								
<b>Failure relay (optional)</b>	25VDC (1A) / 60VDC (0,3A)								
<b>Weight</b>	500 g								
<b>Dimensions H x W x D</b>	H: 115mm W: 61mm D: 113mm								
<b>Housing</b>	Stainless steel, powder coated								

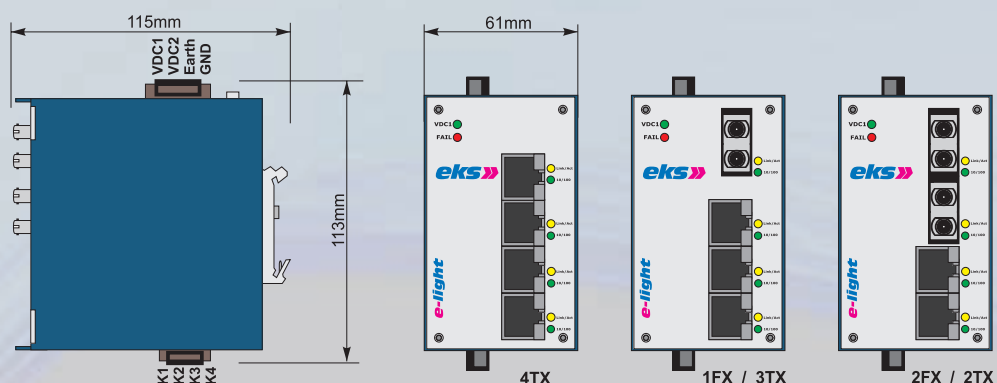

# EL100-2U

## 6/7/8-Port Switch, unmanaged

Die Serie EL100-2U umfasst unmanaged 6/7/8-Port-Switches für 10/100MBit/s mit wahlweise bis zu acht RJ45-Ethernet-Ports und bis zu drei optischen Ports, die mit Kunststoff-, HCS-, Multimode- oder Singlemode-LWL funktionieren. Weitere Features sind Auto-Negotiation, MDX/MDIX, redundante Spannungsversorgung und erweiterter Temperaturbereich. LEDs signalisieren fehlerhafte Zustände.

In Verbindung mit den anderen Systemen der Baureihen e-light bzw. DragonLine lassen sich somit individuelle Applikationen realisieren.

## 6/7/8-Port Switch, unmanaged

The series EL100-2U contains unmanaged 6/7/8-Port-switches for 10/100MBit/s with optionally up to eight RJ45-Ethernet-Ports and up to three optical ports which operate with POF, HCS-, multimode or singlemode fiber optic. Additional features are autonegotiation, MDX/ MDIX, redundant power supply and extended temperature range. LEDs are able to signal defective states.

In connection with other systems out of the e-light and DragonLine series respectively, individual applications can be realized.



Type ST EL100 2U/	8TX	6TX-1FX- MM-ST	6TX-2FX- MM-ST	4TX-3FX- MM-ST	2TX-4FX- MM-ST	6TX-1FX- SM-ST	6TX-2FX- SM-ST	4TX-3FX- SM-ST	2TX-4FX- SM-ST
Order no.	0 4000 01 00 00 00	0 4000 01 00 00 31	0 4000 01 00 31 31	0 4000 01 31 31 31	0 4000 01 31 31 31 31	0 4000 01 00 00 51	0 4000 01 00 51 51	0 4000 01 51 51 51	0 4000 01 51 51 51 51
Type SC EL100 2U/		6TX-1FX- MM-SC	6TX-2FX- MM-SC	4TX-3FX- MM-SC	2TX-4FX- MM-SC	6TX-1FX- SM-SC	6TX-2FX- SM-SC	4TX-3FX- SM-SC	2TX-4FX- SM-SC
Order no.		0 4000 01 00 00 33	0 4000 01 00 33 33	0 4000 01 33 33 33	0 4000 01 33 33 33 33	0 4000 01 00 00 53	0 4000 01 00 53 53	0 4000 01 53 53 53	0 4000 01 53 53 53 53
Type E2000 EL100 2U/		6TX-1FX- MM-E2	6TX-2FX- MM-E2	4TX-3FX- MM-E2	2TX-4FX- MM-E2	6TX-1FX- SM-E2	6TX-2FX- SM-E2	4TX-3FX- SM-E2	2TX-4FX- SM-E2
Order no.		0 4000 01 00 00 35	0 4000 01 00 35 35	0 4000 01 35 35 35	0 4000 01 35 35 35 35	0 4000 01 00 00 55	0 4000 01 00 55 55	0 4000 01 55 55 55	0 4000 01 55 55 55 55
Fiber		Multimode 62,5 (50) /125µm				Singlemode 9/125µm			
Optical budget		12 dB				16 dB			
FO range		up to 5 km (1 dB/km)				30 km, others up to 100 km on request (0,3 dB/km)			
Wavelength	1310 nm								
Status - LEDs	System fault (red) / Port LEDs (yellow/green) / Power supply (green)								
Power consumption	5 W, 200 mA (24 VDC)								
Operating voltage	12-30 VDC redundant power supply, other voltages on request								
Potential separation	500 V								
Operating temperature	-40°C - +70°C (Multimode and Singlemode with ST or SC) -20°C - +55°C (all others)								
Storage temperature	-40°C - +85°C								
EMC	EN61000-6-2 / EN55022 +A1 + A2 Class A								
Failure relay (optional)	25VDC (1A) / 60VDC (0,3A)								
Weight	500 g								
Dimensions H x W x D	H: 115mm W: 61mm D: 113mm								
Housing	Stainless steel, powder coated								

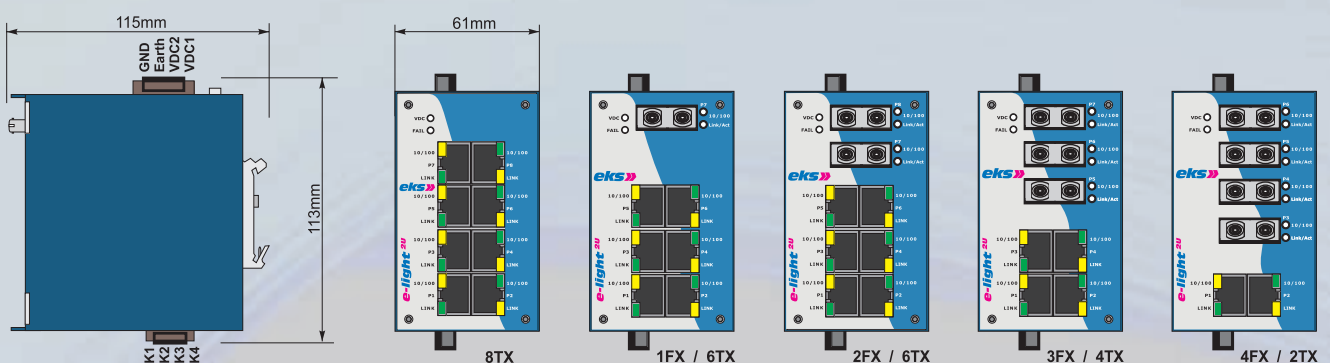

# EL1000-2G

## Gigabit 7-Port Switch, unmanaged

Die Serie EL1000-2G umfasst unmanaged 7-Port-Switches für 10/100/1000MBit/s mit 3xTX + 4xFX und 5xTX + 2xFX Ports. Die optischen Ports funktionieren mit Multimode- oder Singlemode-LWL. Weitere Features sind Auto-Negotiation, MDX/MDIX, redundante Spannungsversorgung und erweiterter Temperaturbereich. LEDs signalisieren fehlerhafte Zustände.

In Verbindung mit den anderen Systemen der Baureihen e-light bzw. DragonLine lassen sich somit individuelle Applikationen realisieren.

## Gigabit 7-Port Switch, unmanaged

The series EL1000-2G contains unmanaged 7-port-switches for 10/100/1000MBit/s with 3xTX + 4xFX and 5xTX + 2xFX ports, which operate with multimode or singlemode fiber optic. Additional features are autonegotiation, MDX/ MDIX, redundant power supply and extended temperature range. LEDs are able to signal defective states.

In connection with other systems out of the e-light and DragonLine series respectively, individual applications can be realized.



Type		5TX-2FX - MM-SC	3TX-4FX - MM-SC		5TX-2FX - SM-SC	3TX-4FX - SM-SC	5TX-2FX - SM-E2	3TX-4FX - SM-E2
Order no. EL1000-2GU/		0 4000 10 00 00 33 33	0 4000 10 33 33 33 33		0 4000 10 00 00 53 53	0 4000 10 53 53 53 53	0 4000 10 00 00 55 55	0 4000 10 55 55 55 55
FO connector		SC	SC		SC	SC	E-2000	E-2000
Fiber		Multimode 62,5 (50) /125 μm			Singlemode 9/125 μm			
Optical budget		7,5 dB			11,5 dB			
FO range		up to 550m (1 dB/km)			10 km, others up to 100 km on request (0,3 dB/km)			
Wavelength		850 nm			1310 nm			
Status - LEDs		TX data per port						
Power supply		12-65 VDC redundant power supply / 8W						
Operating temperature		-40°C - +55°C						
Storage temperature		-40°C - +85°C						
EMC		EN61000-6-2 / EN55022 +A1 + A2 Class A						
Weight		850 g						
Dimensions H x W x D		H: 145mm W: 70mm D: 130mm						
Housing		Stainless steel, powder coated						

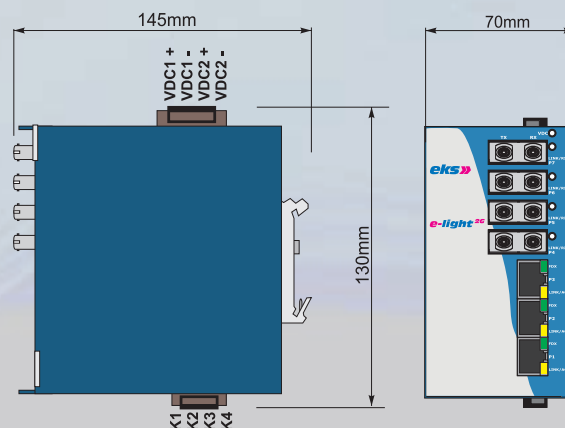

# EL100-2M

## Managed 8-Port Switch mit bis zu 4 FX-Ports

Die gemanagten Switche der Serie EL100-2M verfügen über eine Ringfunktionalität auf Basis des Pathfinder Rings (P-Ring) mit einer schnellen Erholzeit von weniger als 300ms.

Über ein Web Management GUI lassen sich alle wichtigen Funktionen wie z.B. Port Mirroring, DHCP Client, IGMP, SNTP, SMTP, Port und Tagged basiertes VLAN, SNMP, RMON, Quality of Service oder Class of Service 802.1p kontrollieren. Zudem steht ein Alarm-Relaisausgang für Systemereignisse zur Verfügung.

EL100-2M ist mit bis zu 4 flexibel konfigurierbaren FX-Ports und bis zu 6 TX-Ports verfügbar. Die Fast Ethernet Switches im Industriedesign sind in einem weiten Temperaturbereich von -25°C bis +60°C einsetzbar und sowohl für die Hutschienen- als auch Wandmontage geeignet. Weitere Details sind Auto-Negotiation, MDX/MDIX und redundante Spannungsversorgung mit einem Eingangsspannungsbereich von 12VDC bis 70VDC. In Verbindung mit den anderen Systemen der Baureihen e-light bzw. DragonLine lassen sich somit individuelle Applikationen realisieren.

Für die Ausführung 2FX/6TX existiert eine DNV-Zulassung.

## Managed 8-Port Switch with up to 4 FX-Ports

EL100-2M is an 8 port switch that features ring function based on the Pathfinder Ring (P-Ring) with a recovery time of less than 300ms.

They are available with up to 4 flexibly configurable FX-ports and up to 6TX-ports. The Fast Ethernet switches with their industrial design are useable in a wide temperature range of -25°C to +60°C and are suitable for both DIN rail mounting and wall fastening.

The EL100-2M highlights are amongst others: Web Management GUI, Port Mirroring, DHCP Client, IGMP, SNTP, SMTP, port and tagged based VLAN, SNMP, RMON, quality of service as well as an alarm relay output for system events. Additional features are autonegotiation, MDX/ MDIX and redundant power supply with an input voltage range from 12VDC to 70VDC. In connection with other systems out of the e-light and DragonLine series respectively, individual applications can be realized.

Version 2FX/6TX is available with a DNV approval.



<b>Type</b> EL100-2M/	6TX-2FX- PO-ST	6TX-2FX- HC-ST	6TX-2FX- MM-ST	6TX-2FX- MM-SC	6TX-2FX- MM-SC- BIDI	6TX-2FX- SM-ST	6TX-2FX- SM-SC	6TX-2FX- SM-SC- BIDI	6TX-2FX- SM-E2
<b>Order no.</b>	0 4100 01 00 01 01 E	0 4100 0100 11 11 E	0 4100 0100 31 31 E	0 4100 0100 33 33 E	0 4100 0100 36 37 E	0 4100 0100 51 51 E	0 4100 0100 53 53 E	0 4100 0100 56 77 E	0 4100 0100 55 55 E
<b>Type</b> EL100-2M/	4TX-4FX- PO-ST	4TX-4FX- HC-ST	4TX-4FX- MM-ST	4TX-4FX- MM-SC	4TX-4FX- MM-SC- BIDI	4TX-4FX- SM-ST	4TX-4FX- SM-SC	4TX-4FX- SM-SC- BIDI	4TX-4FX- SM-E2
<b>Order no.</b>	0 4100 01 01 01 01 01E	0 4100 01 11 11 11 11E	0 4100 01 31 31 31 31E	0 4100 01 33 33 33 33E	0 4100 01 36 37 36 37E	0 4100 01 51 51 51 51E	0 4100 01 53 53 53 53E	0 4100 01 56 77 56 77E	0 4100 01 55 55 55 55E
<b>Fiber</b>	POF 980/1000µm	HCS/ PCF 200/230µm	Multimode 62,5 (50) /125µm			Singlemode 9/125µm			
<b>Optical budget</b>	12 dB	12 dB	12 dB / BIDI 15 dB			16 dB			
<b>FO range</b>	40 m	200 m	up to 5 km			30 km, others on request			
<b>Wavelength</b>	650 nm	850 nm	1310 nm						
<b>Status - LEDs</b>	System fault (red) / Port LEDs (yellow / green) / Power supply (green)								
<b>Power supply</b>	12-70 VDC redundant power supply / 8W								
<b>Potential separation</b>	500 V								
<b>Operating temperature</b>	-40°C - +70°C (Multimode and Singlemode with ST or SC) -20°C - +55°C (all others)								
<b>Storage temperature</b>	-40°C - +85°C								
<b>EMC</b>	EN61000-6-2 / EN55022 +A1 + A2 Class A								
<b>Weight</b>	850 g								
<b>Dimensions H x W x D</b>	H: 145mm W: 70mm D: 130mm								
<b>Housing</b>	Stainless steel, powder coated								
<b>IEEE</b>	IEEE 802.3 10Base-T / IEEE 802.3u 100Base-TX and 100Base-FX Fast Ethernet / IEEE802.3x Flow Control and Back-pressure / IEEE802.1d STP / IEEE802.1w RSTP / IEEE802.1p class of service / IEEE802.1Q VLAN Tag								
<b>Management</b>	SNMP management / Web interface management								
<b>SNMP MIB</b>	RFC 1213 MIBII / RFC 1493 Bridge MIB / RMON RFC 1757 / RFC 2674 VLAN MIB / RFC 1643 Ethernet like MIB / RFC 1215 Trap MIB / Private MIB for switch information, ring, port alarm, TFTP firmware upgrade, reset, port mirror, IP security management, IGMP management MIB								
<b>Technology</b>	Store and forward switching architecture								
<b>MAC Address table</b>	2K MAC address table								
<b>Ring</b>	Pathfinder-Ring (P-Ring) / 2 Ports for the ring guarantee a recovery time of less than 300 ms								
<b>VLAN</b>	VLAN / IEEE802.1Q Tag based VLAN								
<b>Class of Service</b>	IEEE802.1p Class of Service with 4 priority queues								
<b>Spanning Tree</b>	IEEE802.1d Spanning Tree and IEEE802.1w Rapid Spanning Tree								
<b>IGMP</b>	IGMP v1 and Query Modus, with up to 256 groups								
<b>SNTP / SMTP</b>	SNTP for time synchronisation / SMTP email alert with up to 4 email accounts								
<b>IP Security</b>	IP-address security to refuse access for unauthorized users								
<b>Port Mirror</b>	Only TX packets or TX and RX packets								
<b>Firmware Update</b>	TFTP firmware update, TFTP backup and restore								
<b>Alarm contact</b>	25VDC (1A) / 60VDC (0,3A)								
<b>Bandwidth control</b>	Ingress and egress with combination possibilities								
<b>DHCP Client</b>	Provides DHCP client function to obtain IP address of the DHCP server								

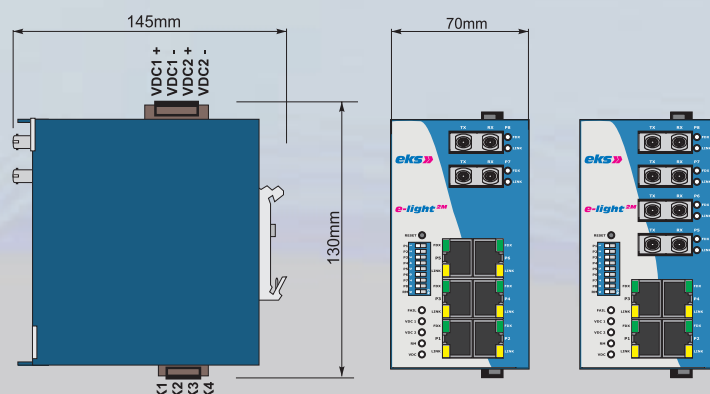

# EL100-2MA

## Managed ProfiNet 8-Port Switch mit 2 FX-Ports

Die gemanagten Switche der Serie EL100-2MA verfügen über eine Ringfunktionalität auf Basis des Media Redundancy Protocol nach IEC 62429 (MRP-Ring), das es dem System ermöglicht, sich von Netzwerkausfällen innerhalb von 200ms oder weniger zu erholen.

Über ein Web Management GUI lassen sich alle wichtigen Funktionen wie z.B. Port Mirroring, DHCP Client, IGMP, SNMP, SMTP, Port und Tagged basiertes VLAN, SNMP, RMON, Quality of Service oder Class of Service 802.1p kontrollieren. Zudem steht ein Alarm-Relaisausgang für Systemereignisse zur Verfügung.

EL100-2MA ist mit bis zu 2 flexibel konfigurierbaren FX-Ports und bis zu 6 TX-Ports verfügbar. Die Fast Ethernet Switches im Industriedesign sind in einem weiten Temperaturbereich von -40°C bis +70°C einsetzbar und sowohl für die Hutschienen- als auch Wandmontage geeignet. Weitere Details sind Auto-Negotiation, MDX/MDIX und redundante Spannungsversorgung mit einem Eingangsspannungsbereich von 12VDC bis 70VDC. In Verbindung mit den anderen Systemen der Baureihen e-light bzw. DragonLine lassen sich somit individuelle Applikationen realisieren.

Für die Ausführung 2FX/6TX existiert eine DNV-Zulassung.

## Managed ProfiNet 8-Port Switch with 2 FX-Ports

EL100-2MA is an 8 port switch that features ring function based on the Media Redundancy Protocol according to IEC 62429 (MRP-Ring), which enables the system, to recover the network after breakdowns within 200ms

They are available with up to 2 flexibly configurable FX-ports and up to 6TX-ports. The Fast Ethernet switches with their industrial design are useable in a wide temperature range of -40°C to +70°C and are suitable for both DIN rail mounting and wall fastening.

The EL100-2MA highlights are amongst others: Web Management GUI, Port Mirroring, DHCP Client, IGMP, SNMP, SMTP, port and tagged based VLAN, SNMP, RMON, quality of service as well as an alarm relay output for system events. Additional features are autonegotiation, MDX/ MDIX and redundant power supply with an input voltage range from 12VDC to 70VDC. In connection with other systems out of the e-light and DragonLine series respectively, individual applications can be realized.

Version 2FX/6TX is available with a DNV approval.

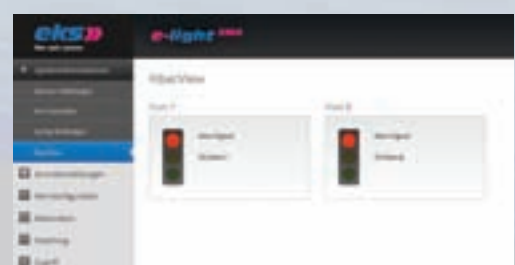



Type	6TX-2FX-PO-ST	6TX-2FX-HC-ST	6TX-2FX-MM-ST	6TX-2FX-MM-SC	6TX-2FX-MM-SC-BIDI	6TX-2FX-SM-ST	6TX-2FX-SM-SC	6TX-2FX-SM-SC-BIDI	6TX-2FX-SM-E2
EL100-2MA/									
Order no.	0 4410 0100 0101EV10-00	0 4410 0100 1111EV10-00	0 4410 0100 3131EV10-00	0 4410 0100 3333EV10-00	0 4410 0100 3637EV10-00	0 4410 0100 5151EV10-00	0 4410 0100 5353EV10-00	0 4410 0100 5677EV10-00	0 4410 0100 5555EV10-00
Fiber	POF 980/1000µm	HCS/ PCF 200/230µm	Multimode 62,5 (50) /125µm			Singlemode 9/125µm			
Optical budget	12 dB	12 dB	12 dB / BIDI 15 dB			16 dB			
FO range	40 m	200 m	up to 5 km			30 km, others on request			
Wavelength	650 nm	850 nm	1310 nm						
Status - LEDs	System fault (red) / Port LEDs (yellow / green) / Power supply (green) / FiberView (green/yellow/red)								
Power supply	12-70 VDC redundant power supply / 8W								
Potential separation	500 V								
Operating temperature	-40°C - +70°C (Multimode and Singlemode with ST or SC) -20°C - +55°C (all others)								
Storage temperature	-40°C - +85°C								
EMC	EN61000-6-2 / EN55022 Class A								
Weight	850 g								
Dimensions H x W x D	H: 145mm W: 70mm D: 130mm								
Housing	Stainless steel, powder coated								
10/100Base TX Ports	6 x RJ45 / Autonegotiation / Auto MDI/MDI-X / Supports length up to 100m (CAT 5)								
IEEE	IEEE 802.3 10Base-T Ethernet / IEEE 802.3u 100Base-TX and 100Base-FX Fast Ethernet / IEEE802.3x Flow Control and Back-pressure / IEEE802.1d spanning tree / IEEE802.1w rapid spanning tree / IEEE802.1p class of service / IEEE802.1Q VLAN Tag								
Management	SNMP management / Web interface management								
SNMP MIB	RFC 1213 MIBII / RFC 1493 Bridge MIB / RMON RFC 1757 / RFC 2674 VLAN MIB / RFC 1643 Ethernet wie MIB / RFC 1215 Trap MIB / Private MIB für Switch Informationen, Ring, Portalarm, TFTP Firmware Update, Reset, Port Mirror, IP Security Management, IGMP Management MIB								
Technology	Store and forward switching architecture								
MAC Address table	2K MAC address table								
Ring	2 ports for the Ring, to guarantee a recovery time of less than 300ms								
VLAN	Port based VLAN / Tagged VLAN IEEE 802.1Q								
Class of Service	IEEE802.1p Class of Service with 4 priority queues per port								
Spanning Tree	IEEE802.1d Spanning Tree and IEEE802.1w Rapid Spanning Tree								
IGMP	IGMP v1 and Query mode, with up to 256 groups								
SNTP / SMTP	SNTP for time synchronization / SMTP server and e-mailaddresses for alarm events								
IP Security	IP-address security to refuse access for unauthorized users								
Port Mirror	Only TX packets or TX and RX packets								
Firmware Update	TFTP firmwareupdate, TFTP backup and restore								
Alarm contact	2 x relay contact 25VDC (1A) / 60VDC (0,3A)								
Rate control	Ingress and Egress with possibility of combination								
DHCP Client	DHCP Client function to get the IP address of the DHCP server								

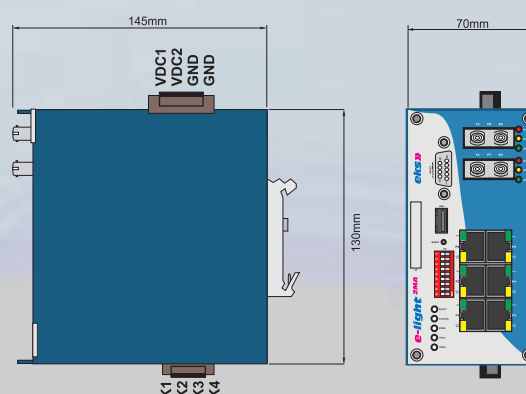

# DL485 / DL485-4W

## RS485-Fiber Optic System, protokolltransparent

Die LWL-Systeme DL485 vernetzen Feldbussysteme mit RS485-Schnittstellen über Lichtwellenleiter. Die optische Vernetzung bietet die sichere Datenübertragung und eignet sich z.B. für MODBUS, MODBUS-RTU, MODNET-1/SFB, BITBUS, SAIA-S-BUS und viele herstellerspezifische Systeme.

Die LWL-Systeme DL485-4W vernetzen Feldbussysteme mit Vierdraht-RS485-Schnittstellen über LWL.

Mit diesem innovativen System lassen sich optische Bus-, Stern- oder Baumstrukturen ebenso realisieren, wie elektrisch-optisch gemischte Strukturen.

LEDs und potenzialfreie Kontakte eines Fehlerrelais signalisieren fehlerhafte Zustände.

FiberView signalisiert die Qualität der Verbindung ähnlich einer Ampel über LED. Steht die „Ampel“ auf „grün“ ist alles in Ordnung. Leuchtet das Signal „gelb“ so bewegt sich das Budget noch innerhalb der Dämpfungstoleranzen, unterschreitet jedoch eine definierte Systemreserve. Diese Vorwarnstufe wird zusätzlich zur LED per potentialfreiem Kontakt signalisiert. Schaltet die „Ampel“ auf „rot“, liegt ein Fehler vor.

## RS485-Fiber Optic System, protocol transparent

The fiber optic systems DL485 connect field bus systems with RS485 interfaces. Optical linking allows safe data transfer and is suitable for MODBUS, MODNET-1/SFB, BIT-BUS, SAIA-S-BUS and several manufacturer-specific systems.

The fiber optic systems DL485-4W connect field bus systems with RS485 four-wire interfaces.

With the help of this innovative system optical bus, star, tree and mixed structures are possible.

LEDs and potential-free contacts of a fault detector relay are able to signal defective states.

FiberView works similarly to a traffic light. If the “traffic light” is green, everything is fine. If the yellow LED lights, the budget is still tolerable, but already below a certain system reserve. Additionally to the LED, this pre-warning level is also signaled by a potential-free contact. If the “traffic light” turns red there is a serious error.



Type	P-ST	P-SMA	MM-ST	MM-SC	MM-SC /BIDI	SM-ST	SM-SC	SM-E2	SM-SC /BIDI
Order no. DL485/	0 1000 6101	0 1000 6102	0 1000 6121	0 1000 6123	0 1000 6123 BIDIA 6123-BIDIB	0 1000 6131	0 1000 6133	0 1000 6135	0 1000 6133 BIDIA 6133-BIDIB
Order no. DL485-2x/	0 1000 6151	0 1000 6152	0 1000 6171	0 1000 6173	0 1000 6173 BIDI	0 1000 6181	0 1000 6183	0 1000 6185	0 1000 6183-BIDI
Data rate max.	1.200 Bit/s to 3 MBit/s								
Transmission type	Half-duplex								
Order no. DL485-4W/	0 1000 6601	0 1000 6602	0 1000 6621	0 1000 6623	0 1000 6623 BIDIA 6623-BIDIB	0 1000 6631	0 1000 6633	0 1000 6635	0 1000 6633 BIDIA 6633-BIDIB
Order no. DL485-4W-2x/	0 1000 6651	0 1000 6652	0 1000 6671	0 1000 6673	0 1000 6673 BIDI	0 1000 6681	0 1000 6683	0 1000 6685	0 1000 6683-BIDI
Data rate max.	1.200 Bit/s to 1,5 MBit/s								
Transmission type	Full-duplex								
FO connector	ST	SMA	ST	SC	SC	ST	SC	E-2000	SC
Fiber	POF or HCS (980/1000 μm) (200/230 μm)		Multimode 62,5 (50) /125 μm			Singlemode 9/125 μm			
Optical budget	12 dB		12 dB			16 dB			
FO range	50 m or 120 m (180dB/km) / (10dB/km)		5 km (1 dB/km)			30 km, others up to 100 km on request (0,3 dB/km)			
Wavelength	650 nm		1310 nm		1310 nm 1550 nm	1310 nm			1310 nm 1550 nm
Data rate max.	1.200 Bit/s to 3 MBit/s								
Transmission type	Half-duplex								
Terminating resistor	Switchable: none or wave impedance (Rw + Rpd + Rpu)								
Cable length electr.	1.200 m (9,6 – 187,5 KBit/s), 400 m (500 KBit/s), 200 m (1.5 MBit/s)								
Connecting plug	9 pole Sub-D female and 6 pole terminal								
Status - LEDs	Power supply (green) / Failure (red) / Data receive (green) / Status (red) / FiberView (red, yellow, green)								
Operating voltage	12-30 VDC, other voltages on request								
Power consumption	5 Watts, 200 mA (24V)								
Potential separation	500 VDC (24 VDC → RS485)								
Operating temperature	-40°C - +70°C (Multimode and Singlemode with ST or SC) -20°C - +55°C (all others)								
EMC	EN61000-6-2 / EN55022 +A1 + A2 Class B								
Weight	500 g								
Dimensions H x W x D	H: 115 mm B: 61 mm D: 113 mm								
Housing	Stainless steel, powder coated								

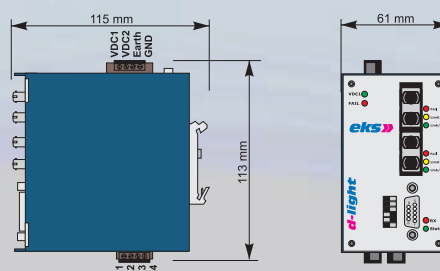

# DL485-MBR

## MODBUS-Fiber Optic System Redundant

Die LWL-Systeme DL485-MBR sichern die optische Datenübertragung in MODBUS-Feldbusnetzwerken mit einer Datenrate von maximal 115,2KBit/s. Ein spezielles redundanzfähiges LWL-System ermöglicht den Aufbau von optischen Ringstrukturen.

Geeignet sind die Systeme der Serie vor allem für Anwendungen mit hohen sicherheitstechnischen Anforderungen wie z.B. Prozessindustrie, Tunnelbelüftungssysteme und in der Bahntechnik.

LEDs und potenzialfreie Kontakte eines Fehlerrelais signalisieren fehlerhafte Zustände.

FiberView signalisiert die Qualität der Verbindung ähnlich einer Ampel über LED. Steht die „Ampel“ auf „grün“ ist alles in Ordnung. Leuchtet das Signal „gelb“ so bewegt sich das Budget noch innerhalb der Dämpfungstoleranzen, unterschreitet jedoch eine definierte Systemreserve. Diese Vorwarnstufe wird zusätzlich zur LED per potentialfreiem Kontakt signalisiert. Schaltet die „Ampel“ auf „rot“, liegt ein Fehler vor.

## MODBUS-Fiber Optic System redundant

The fiber optic systems DL485-MBR secure the optical data transfer within MODBUS networks up to a data speed of 115,2KBit/s. Our special multifunctional fiber optic system allows the construction of optical ring structures.

The system of this series is especially suitable for applications with strict safety-related requirements as for instance: process industry, tunnel ventilation systems and railway technology.

LEDs and potential-free contacts of a fault detector relay are able to signal defective states.

FiberView works similarly to a traffic light. If the "traffic light" is green, everything is fine. If the yellow LED lights, the budget is still tolerable, but already below a certain system reserve. Additionally to the LED, this pre-warning level is also signaled by a potential-free contact. If the "traffic light" turns red there is a serious error.



Type	P-ST	P-SMA	MM-ST	MM-SC	MM-SC /BIDI	SM-ST	SM-SC	SM-E2	SM-SC /BIDI
Order no. DL485-MBR/	0 1000 7951	0 1000 7952	0 1000 7971	0 1000 7973	0 1000 7973-BIDI	0 1000 7981	0 1000 7983	0 1000 7985	0 1000 7983-BIDI
FO connector	ST	SMA	ST	SC	SC	ST	SC	E-2000	SC
Fiber	POF or HCS (980/1000 μm) (200/230 μm)		Multimode 62,5 (50) /125 μm			Singlemode 9/125 μm			
Optical budget	12 dB		12 dB			16 dB			
FO range	50 m or 120 m (180dB/km) / (10dB/km)		5 km (1 dB/km)			30 km, others up to 100 km on request (0,3 dB/km)			
Wavelength	650 nm		1310 nm		1310 nm 1550 nm	1310 nm			1310 nm 1550 nm
Data rate max.	9,6 KBit/s, 19,2 KBit/s, 38,4 KBit/s, 57,6 KBit/s or 115,2 KBit/s								
Transmission type	Half-duplex								
Terminating resistor	Switchable: none or wave impedance (Rw + Rpd + Rpu)								
Cable length electr.	1.200 m								
Connecting plug	9 pole Sub-D female and 6 pole terminal								
Status - LEDs	Power supply (green) / Failure (red) / Data receive (green) / Status (red) / FiberView (red, yellow, green)								
Operating voltage	12-30 VDC, other voltages on request								
Power consumption	5 Watts, 200 mA (24V)								
Potential separation	500 VDC (24 VDC → RS485)								
Operating temperature	-40°C - +70°C (Multimode and Singlemode with ST or SC) -20°C - +55°C (all others)								
Storage temperature	-40°C - +85°C								
EMC	EN61000-6-2 / EN55022 +A1 + A2 Class B								
Failure relay	25VDC (1A) / 60VDC (0,3A)								
Weight	500 g								
Dimensions H x W x D	H: 115 mm B: 61 mm D: 113 mm								
Housing	Stainless steel, powder coated								

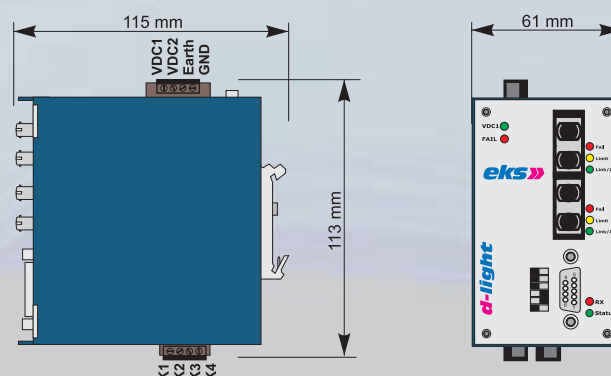

# DL485-PB / DL485-PBR

## PROFIBUS-Fiber Optic System

Die LWL-Systeme DL485-PB vernetzen Profibus-Feldbusnetzwerke über Lichtwellenleiter. Mit diesem innovativen System lassen sich optische Bus-, Stern- oder Baumstrukturen ebenso realisieren, wie elektrisch-optisch gemischte Strukturen.

Das redundanzfähige LWL-System DL485-PBR ermöglicht zudem den Aufbau von optischen Ringstrukturen.

LEDs und potenzialfreie Kontakte eines Fehlerrelais signalisieren fehlerhafte Zustände.

FiberView signalisiert die Qualität der Verbindung ähnlich einer Ampel über LED. Steht die „Ampel“ auf „grün“ ist alles in Ordnung. Leuchtet das Signal „gelb“ so bewegt sich das Budget noch innerhalb der Dämpfungstoleranzen, unterschreitet jedoch eine definierte Systemreserve. Diese Vorwarnstufe wird zusätzlich zur LED per potentialfreiem Kontakt signalisiert. Schaltet die „Ampel“ auf „rot“, liegt ein Fehler vor.

## PROFIBUS-Fiber Optic System

The systems DL485-PB connect Profibus-field bus networks by fiber optics. With the help of this innovative system, optical bus, star, tree and mixed structures are possible.

The special multifunctional fiber optic system DL485-PBR also allows the construction of optical ring structures. The system of this series is especially suitable for applications with strict safety-related requirements as for instance: process industry, tunnel ventilation systems and railway technology.

LEDs and potential-free contacts of a fault detector relay are able to signal defective states.

FiberView works similarly to a traffic light. If the “traffic light” is green, everything is fine. If the yellow LED lights, the budget is still tolerable, but already below a certain system reserve. Additionally to the LED, this pre-warning level is also signaled by a potential-free contact. If the “traffic light” turns red there is a serious error.



Type	P-ST	P-SMA	MM-ST	MM-SC	MM-SC /BIDI	SM-ST	SM-SC	SM-E2	SM-SC /BIDI
Order no. DL485-PB/	0 1000 6201	0 1000 6202	0 1000 6221	0 1000 6223	0 1000 6223-BIDIA 6223-BIDIB	0 1000 6231	0 1000 6233	0 1000 6235	0 1000 6233-BIDI
Order no. DL485-PB-2x/	0 1000 6251	0 1000 6252	0 1000 6271	0 1000 6273	0 1000 6273-BIDI	0 1000 6281	0 1000 6283	0 1000 6285	0 1000 6283-BIDI
Order no. DL485-PBR/	0 1000 6351	0 1000 6352	0 1000 6371	0 1000 6373	0 1000 6373-BIDI	0 1000 6381	0 1000 6383	0 1000 6385	0 1000 6383-BIDI
FO connector	ST	SMA	ST	SC	SC	ST	SC	E-2000	SC
Fiber	POF or HCS (980/1000 μm) (200/230 μm)		Multimode 62,5 (50) /125 μm			Singlemode 9/125 μm			
Optical budget	12 dB		12 dB			16 dB			
FO range	50 m or 120 m (180dB/km) / (10dB/km)		5 km (1 dB/km)			30 km, others up to 100 km on request (0,3 dB/km)			
Wavelength	650 nm		1310 nm		1310 nm 1550 nm	1310 nm			1310 nm 1550 nm
Data rate max.	12MBit/s								
Transmission type	Half-duplex								
Signal delay	RS485 ↔ Fiber Optic : < 3 T <sub>Bit</sub> / Tx ↔ Rx : 11 T <sub>Bit</sub>								
Terminating resistor	Switchable: none or wave impedance (R <sub>w</sub> + R <sub>pd</sub> + R <sub>pu</sub> )								
Cable length electr.	1.200m (9,6 – 187,5KBit/s), 400m (500KBit/s), 200m (1.5MBit/s), 100m (3MBit/s - 12MBit/s)								
Connecting plug	9 pole Sub-D female and 6 pole terminal								
Status - LEDs	Power supply (green) / Failure (red) / Data receive (green) / Status (red) / FiberView (red, yellow, green)								
Operating voltage	12-30 VDC, other voltages on request								
Power consumption	5 Watts, 200 mA (24V)								
Potential separation	500 VDC (24 VDC → Profibus RS485)								
Operating temperature	-40°C - +70°C (Multimode and Singlemode with ST or SC) -20°C - +55°C (all others)								
Storage temperature	-40°C - +85°C								
EMC	EN61000-6-2 / EN55022 +A1 + A2 Class B								
Failure relay	25VDC (1A) / 60VDC (0,3A)								
Weight	500 g								
Dimensions H x W x D	H: 115mm W: 61mm D: 113mm								
Housing	Stainless steel, powder coated								

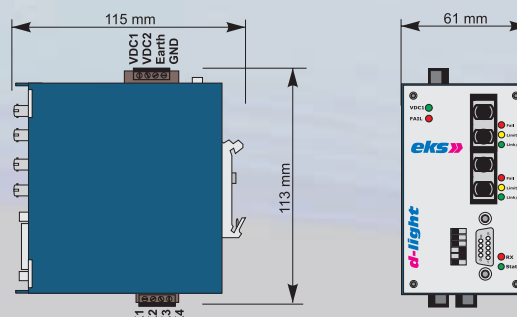

# DL485-MBP / DL485-MBPR

## MODBUS-PLUS-Fiber Optic System

Die LWL-Systeme DL485-MBP vernetzen Feldbusnetzwerke mit Modbus-Plus-Schnittstelle über Lichtwellenleiter. Mit diesem innovativen System lassen sich optische Bus-, Stern- oder Baumstrukturen ebenso realisieren, wie elektrisch-optisch gemischte Strukturen.

Das redundanzfähige LWL-System DL485-MBPR ermöglicht zudem den Aufbau von optischen Ringstrukturen.

LEDs und potenzialfreie Kontakte eines Fehlerrelais (optional für DL485-MBP) signalisieren fehlerhafte Zustände.

## MODBUS-PLUS-Fiber Optic System

The fiber optic systems DL485-MBP connect a Modbus-Plus interface to optical field bus networks. With the help of this innovative system optical bus, star, tree and mixed structures are possible.

The special multifunctional fiber optic system DL485-MBPR also allows the construction of optical ring structures.

LEDs and potential-free contacts (optional for DL485-MBP) of a fault detector relay are able to signal defective states.





Type	P-ST	P-SMA	MM-ST	MM-SC	MM-SC /BIDI	SM-ST	SM-SC	SM-E2	SM-SC /BIDI
Order no. DL485-MBP/	0 1000 6401	0 1000 6402	0 1000 6421	0 1000 6423	0 1000 6423 BIDIA 6423-BIDIB	0 1000 6431	0 1000 6433	0 1000 6435	0 1000 6433-BIDIA 6433-BIDIB
Order no. DL485-MBP-2x/	0 1000 6451	0 1000 6452	0 1000 6471	0 1000 6473	0 1000 6473-BIDI	0 1000 6481	0 1000 6483	0 1000 6485	0 1000 6483-BIDI
Order no. DL485-MBPR/	0 1000 8551	0 1000 8552	0 1000 8571	0 1000 8573	0 1000 8573-BIDI	0 1000 8581	0 1000 8583	0 1000 8585	0 1000 8583-BIDI
FO connector	ST	SMA	ST	SC	SC	ST	SC	E-2000	SC
Fiber	POF or HCS (980/1000 μm) (200/230 μm)		Multimode 62,5 (50) /125 μm			Singlemode 9/125 μm			
Optical budget	12 dB		12 dB			16 dB			
FO range	50 m or 120 m (180dB/km) / (10dB/km)		5 km (1 dB/km)			30 km, others up to 100 km on request (0,3 dB/km)			
Wavelength	650 nm		1310 nm	1310 nm 1550 nm	1310 nm			1310 nm 1550 nm	
Data rate max.	1 MBit/s								
Transmission type	Half-duplex								
Signal delay	Modbus Plus Interface ↔ Fiber Optic: < 400ns / Tx ↔ Rx : 500ns MBPR : MODBUS Plus Interface ↔ Fiber Optic : < 1μs								
Terminating resistor	According to MODBUS Plus specifications: no terminating resistors in device								
Cable length electr.	50 m								
Connecting plug	9 pole Sub-D female and 6 pole terminal								
Status - LEDs	Power supply (green) / Data (yellow) / Status (red)								
Operating voltage	12-30 VDC, other voltages on request								
Power consumption	5 Watts, 200 mA (24V)								
Potential separation	500 VDC (24 VDC → Modbus Plus Interface)								
Operating temperature	-40°C - +70°C (Multimode and Singlemode with ST or SC) -20°C - +55°C (all others)								
Storage temperature	-40°C - +85°C								
Failure relay	25VDC (1A) / 60VDC (0,3A)								
EMC	EN61000-6-2 / EN55022 +A1 + A2 Class B								
Weight	500 g								
Dimensions H x W x D	H: 115mm W: 61mm D: 113mm								
Housing	Stainless steel, powder coated								

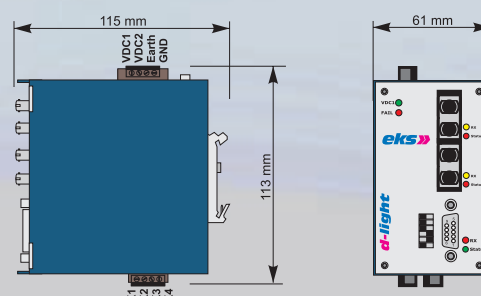

# DL CAN / DL CAN-R

## CAN-Fiber Optic System, protokolltransparent

Die LWL-Systeme DL CAN vernetzen CAN-Feldbusnetzwerke (z. B. Offenes CAN, CANopen, DeviceNet) über Lichtwellenleiter. Mit diesem innovativen System lassen sich optische Bus-, Stern- oder Baumstrukturen ebenso realisieren, wie elektrisch-optisch gemischte Strukturen.

Das redundanzfähige LWL-System DL CAN-R ermöglicht zudem den Aufbau von optischen Ringstrukturen.

LEDs und potenzialfreie Kontakte eines Fehlerrelais signalisieren fehlerhafte Zustände.

FiberView signalisiert die Qualität der Verbindung ähnlich einer Ampel über LED. Steht die „Ampel“ auf „grün“ ist alles in Ordnung. Leuchtet das Signal „gelb“ so bewegt sich das Budget noch innerhalb der Dämpfungstoleranzen, unterschreitet jedoch eine definierte Systemreserve. Diese Vorwarnstufe wird zusätzlich zur LED per potenzialfreiem Kontakt signalisiert. Schaltet die „Ampel“ auf „rot“, liegt ein Fehler vor.

## CAN-Fiber Optic System

The systems DL CAN connect CAN field bus networks (e.g. CAN, CANopen, DeviceNet) via fiber optics. With the help of this innovative system, optical bus, star, tree and mixed structures are possible.

The special multifunctional fiber optic system DL CAN-R also allows the construction of optical ring structures.

LEDs and potential-free contacts of a fault detector relay are able to signal defective states.

FiberView works similarly to a traffic light. If the “traffic light” is green, everything is fine. If the yellow LED lights, the budget is still tolerable, but already below a certain system reserve. Additionally to the LED, this pre-warning level is also signaled by a potential-free contact. If the “traffic light” turns red there is a serious error.



Type	P-ST	P-SMA	MM-ST	MM-SC	MM-SC /BIDI	SM-ST	SM-SC	SM-E2	SM-SC /BIDI
Order no. DLCAN/	0 1000 7401	0 1000 7402	0 1000 7421	0 1000 7423	0 1000 7423-BIDI	0 1000 7431	0 1000 7433	0 1000 7435	0 1000 7433-BIDI
Order no. DLCAN-2x/	0 1000 7451	0 1000 7452	0 1000 7471	0 1000 7473	0 1000 7473-BIDI	0 1000 7481	0 1000 7483	0 1000 7485	0 1000 7483 BIDI
Order no. DLCAN-R/	0 1000 7551	0 1000 7552	0 1000 7571	0 1000 7573	0 1000 7573 BIDI	0 1000 7581	0 1000 7583	0 1000 7585	0 1000 7583-BIDI
FO connector	ST	SMA	ST	SC	SC	ST	SC	E-2000	SC
Fiber	POF or HCS (980/1000 μm) (200/230 μm)		Multimode 62,5 (50) /125 μm			Singlemode 9/125 μm			
Optical budget	12 dB		12 dB			16 dB			
FO range	50 m or 120 m (180dB/km) / (10dB/km)		5 km (1 dB/km)			30 km, others up to 100 km on request (0,3 dB/km)			
Wavelength	650 nm		1310 nm			1310 nm			
Data rate max.	1000, 800, 500, 250, 125, 100, 50, 22,2, 20 and 10 Kbaud switchable by DIP-switch								
Identifier in Network	11 Bit Identifier, 29 Bit Identifier or both								
Transmission type	Half-duplex								
Terminating resistor	Switchable: none or wave impedance (Rw)								
Cable length electr.	According to CAN-specifications								
Connecting plug	9 pole Sub-D female and 6 pole terminal								
Status - LEDs	Power supply (green) / Failure (red) / Data receive (green) / Status (red) / FiberView (red, yellow, green)								
Operating voltage	12-30 VDC, other voltages on request								
Power consumption	5 Watts, 200 mA (24V)								
Potential separation	500 VDC (24 VDC → CAN Interface)								
Operating temperature	-40°C - +70°C (Multimode and Singlemode with ST or SC) -20°C - +55°C (all others)								
Storage temperature	-40°C - +85°C								
EMC	EN61000-6-2 / EN55022 +A1 + A2 Class B								
Failure relay	25VDC (1A) / 60VDC (0,3A)								
Weight	500 g								
Dimensions H x W x D	H: 115mm W: 61mm D: 113mm								
Housing	Stainless steel, powder coated								

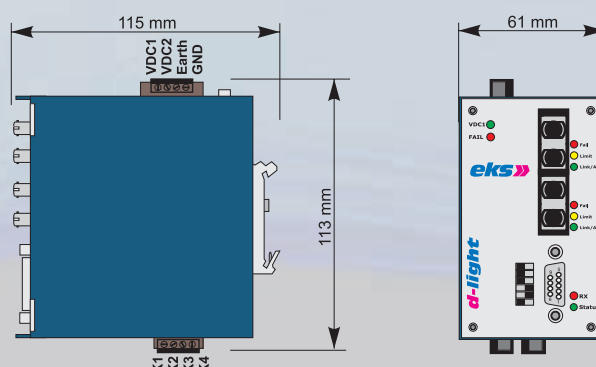

# DL422

## RS422-Fiber Optic System

Die LWL-Systeme DL-422 vernetzen Applikationen mit RS422-Schnittstelle über Lichtwellenleiter.

Mit diesem innovativen System lassen sich optische Bus-, Stern- oder Baumstrukturen ebenso realisieren, wie elektrisch-optisch gemischte Strukturen.

LEDs und optional potenzialfreie Kontakte eines Fehlerrelais signalisieren fehlerhafte Zustände.

## RS422-Fiber Optic System

The fiber optic systems DL422 connect applications with a RS422 interface via fiber optics.

With the help of this innovative system optical bus, star, tree and mixed structures are possible.

LEDs and potential-free contacts (optional) of a fault detector relay are able to signal defective states.



Type	P-ST	P-SMA	MM-ST	MM-SC	MM-SC /BIDI	SM-ST	SM-SC	SM-E2	SM-SC /BIDI
Order no. DL422/	0 1000 2101	0 1000 2102	0 1000 2121	0 1000 2123	0 1000 2123-BIDIA 2123 BIDIB	0 1000 2131	0 1000 2133	0 1000 2135	0 1000 2133 BIDIA 2133 BIDIB
Order no. DL422-2x/	0 1000 2151	0 1000 2152	0 1000 2171	0 1000 2173	0 1000 2173-BIDI	0 1000 2181	0 1000 2183	0 1000 2185	0 1000 2183-BIDI
FO connector	ST	SMA	ST	SC	SC	ST	SC	E-2000	SC
Fiber	POF or HCS (980/1000 μm) (200/230 μm)		Multimode 62,5 (50) /125 μm			Singlemode 9/125 μm			
Optical budget	12 dB		12 dB			16 dB			
FO range	50 m or 120 m (180dB/km) / (10dB/km)		5 km (1 dB/km)			30 km, others up to 100 km on request (0,3 dB/km)			
Wavelength	650 nm		1310 nm		1310nm 1550nm	1310 nm			1310nm 1550nm
Data rate max.	1,5MBit/s (divided by number of connectors)								
Transmission type	Duplex, half-duplex with DL-422/2x								
Terminating resistor	switchable: none or pull-up resistor (Rp) or wave impedance (Rw)								
Cable length electr.	50 m								
Connecting plug	9 pole Sub-D female and 6 pole terminal								
Status - LEDs	Power supply (green) / Data (yellow) / Status (red)								
Operating voltage	12-30 VDC, other voltages on request								
Power consumption	5 Watts, 200 mA (24V)								
Potential separation	500 VDC (24 VDC → RS422)								
Operating temperature	-40°C - +70°C (Multimode and Singlemode with ST or SC) -20°C - +55°C (all others)								
Storage temperature	-40°C - +85°C								
EMC	EN61000-6-2 / EN55022 +A1 + A2 Class B								
Weight	500 g								
Dimensions H x W x D	H: 115mm W: 61mm D: 113mm								
Housing	Stainless steel, powder coated								

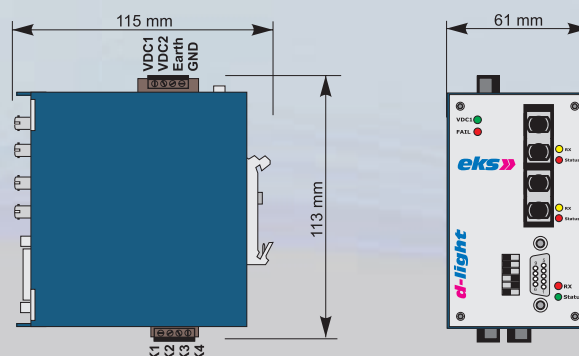

# DL232 / DL232-R

## RS232-Fiber Optic System

Die LWL-Systeme DL232 verbinden Systeme mit RS232-Schnittstelle über Lichtwellenleiter, die über Software-handshake (Xon/Xoff) miteinander kommunizieren. Mit diesem innovativen System lassen sich optische Punkt-zu-Punkt und Bus-Strukturen realisieren.

Das redundanzfähige LWL-System DL232-R ermöglicht zudem den Aufbau von optischen Ringstrukturen.

LEDs und potenzialfreie Kontakte eines Fehlerrelais (optional für DL232) signalisieren fehlerhafte Zustände.

FiberView signalisiert die Qualität der Verbindung ähnlich einer Ampel über LED. Steht die „Ampel“ auf „grün“ ist alles in Ordnung. Leuchtet das Signal „gelb“ so bewegt sich das Budget noch innerhalb der Dämpfungstoleranzen, unterschreitet jedoch eine definierte Systemreserve. Diese Vorwarnstufe wird zusätzlich zur LED per potentialfreiem Kontakt signalisiert. Schaltet die „Ampel“ auf „rot“, liegt ein Fehler vor.

## RS232-Fiber Optic System

The fiber optic systems DL232 connect systems with a RS232-interface via fiber optics. The DL232 allows communication via software-handshake (Xon/ Xoff). With the help of this innovative system optical bus, star, tree and mixed structures are possible.

The special multifunctional fiber optic system DL232-R also allows the construction of optical ring structures.

LEDs and potential-free contacts (optional for DL232) of a fault detector relay are able to signal defective states.

FiberView works similarly to a traffic light. If the "traffic light" is green, everything is fine. If the yellow LED lights, the budget is still tolerable, but already below a certain system reserve. Additionally to the LED, this pre-warning level is also signaled by a potential-free contact. If the "traffic light" turns red there is a serious error.



Type	P-ST	P-SMA	MM-ST	MM-SC	MM-SC /BIDI	SM-ST	SM-SC	SM-E2	SM-SC /BIDI
Order no. DL232/	0 1000 1101	0 1000 1102	0 1000 1121	0 1000 1123	0 1000 1123-BIDIA 1123-BIDIB	0 1000 1131	0 1000 1133	0 1000 1135	0 1000 1133-BIDIA 1133-BIDIB
Order no. DL232-2x/	0 1000 1151	0 1000 1152	0 1000 1171	0 1000 1173	0 1000 1173-BIDI	0 1000 1181	0 1000 1183	0 1000 1185	0 1000 1183-BIDI
Order no. DL232-R/	0 1000 1351	0 1000 1352	0 1000 1371	0 1000 1373	0 1000 1373-BIDI	0 1000 1381	0 1000 1383	0 1000 1385	0 1000 1383-BIDI
FO connector	ST	SMA	ST	SC	SC	ST	SC	E-2000	SC
Fiber	POF or HCS (980/1000 μm) (200/230 μm)		Multimode 62,5 (50) /125 μm			Singlemode 9/125 μm			
Optical budget	12 dB		12 dB			16 dB			
FO range	50 m or 120 m (180dB/km) / (10dB/km)		5 km (1 dB/km)			30 km, others up to 100 km on request (0,3 dB/km)			
Wavelength	650 nm		1310 nm	1310nm 1550nm	1310 nm			1310nm 1550nm	
Data rate max.	115,2 KBit/s								
Transmission type	duplex, half-duplex with DL-232/2x and DL-232R								
Operation type	DTE or DCE switchable with DIP-switch								
Cable length electr.	15 m								
Connecting plug	9 pole Sub-D female and 6 pole terminal								
Status - LEDs	Power supply (green) / Data (yellow) / Status (red)								
Operating voltage	12-30 VDC, other voltages on request								
Power consumption	5 Watts, 200 mA (24V)								
Potential separation	500 VDC (24 VDC → RS232)								
Operating temperature	-40°C - +70°C (Multimode and Singlemode with ST or SC) -20°C - +55°C (all others)								
Storage temperature	-40°C - +85°C								
EMC	EN61000-6-2 / EN55022 +A1 + A2 Class B								
Failure relay	25VDC (1A) /60VDC (0,3A)								
Weight	500 g								
Dimensions H x W x D	H: 115mm W: 61mm D: 113mm								
Housing	Stainless steel, powder coated								

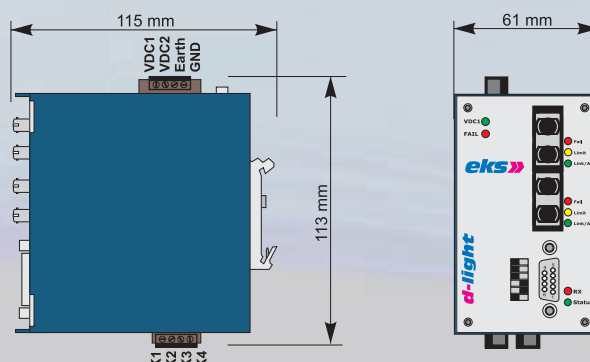

# DL232-MUX

## RS232-Multiplexer-Fiber Optic System

Das Übertragungssystem DL232-MUX ist ein Multiplexer für 4xRS232-Signale bidirektional über LWL. Somit können neben dem RxD- und TxD Signal auch noch bis zu drei Hardware-Handshake-Signale wie RTS, CTS, DCD, DSR und DTR übertragen werden.

Die RS232-Multiplexer haben eine Pinbelegung wie Modems. Zwei Multiplexer, die über LWL verbunden sind, kreuzen die Leitungen und wirken daher wie ein Nullmodem-Kabel. Für die Verbindung von zwei DTE-Endgeräten (mit PC-Pinbelegung) benötigen Sie daher zwei 1:1-Kabel, um die Endgeräte an die Multiplexer anzuschließen. Endgeräte mit einer DCE-Pinbelegung (Modem-Pinbelegung) müssen über ein Nullmodem-Kabel an den Multiplexer angeschlossen werden.

LEDs und optional potenzialfreie Kontakte eines Fehlerrelais signalisieren fehlerhafte Zustände.

## RS232-Multiplexer-Fiber Optic System

The system DL232-MUX is a multiplexer for 4xRS232 signals, working bidirectionally via fiber optics. Thus, in addition to the RxD and TxD signals, hardware-handshake signals as RTS, CTS, DCD, DSR and DTR can be transferred, too.

RS232-multiplexers have a similar pin assignment as modems. Two multiplexers, connected by fiber optics, cross the wires and operate like a null modem cable.

Hence, connecting two data processing terminals (with PC pin assignment) requires two 1:1 cables to be able to link the terminals to the multiplexers. Terminals with a DCE- pin assignment have to be connected to the multiplexer via a null modem cable.

LEDs and potential-free contacts (optional) of a fault detector relay are able to signal defective states.





Type	P-ST	P-SMA	MM-ST	MM-SC	MM-SC /BIDI	SM-ST	SM-SC	SM-E2	SM-SC /BIDI
Order no. DL232-MUX/	0 1000 1201	0 1000 1202	0 1000 1221	0 1000 1223	0 1000 1223 BIDIA 1223-BIDIB	0 1000 1231	0 1000 1233	0 1000 1235	0 1000 1233-BIDIA 1233-BIDIB
FO connector	ST	SMA	ST	SC	SC	ST	SC	E-2000	SC
Fiber	POF or HCS (980/1000 μm) (200/230 μm)		Multimode 62,5 (50) /125 μm			Singlemode 9/125 μm			
Optical budget	12 dB		12 dB			16 dB			
FO range	50 m or 120 m (180dB/km) / (10dB/km)		5 km (1 dB/km)			30 km, others up to 100 km on request (0,3 dB/km)			
Wavelength	650 nm		1310 nm		1310nm 1550nm	1310 nm			1310nm 1550nm
Data rate max.	115,2KBit/s								
Transmission type	duplex								
Operation type	up to 4 signals of RS232 bidirectional								
Cable length electr.	15 m								
Connecting plug	9 pole Sub-D female								
Status - LEDs	Power supply (green) / Data (yellow) / Status (red)								
Operating voltage	12-30 VDC, other voltages on request								
Power consumption	5 Watts, 200 mA (24V)								
Potential separation	500 VDC (24 VDC → RS232)								
Operating temperature	-40°C - +70°C (Multimode and Singlemode with ST or SC) -20°C - +55°C (all others)								
Storage temperature	-40°C - +85°C								
EMC	EN61000-6-2 / EN55022 +A1 + A2 Class B								
Weight	500 g								
Dimensions H x W x D	H: 115mm W: 61mm D: 113mm								
Housing	Stainless steel, powder coated								

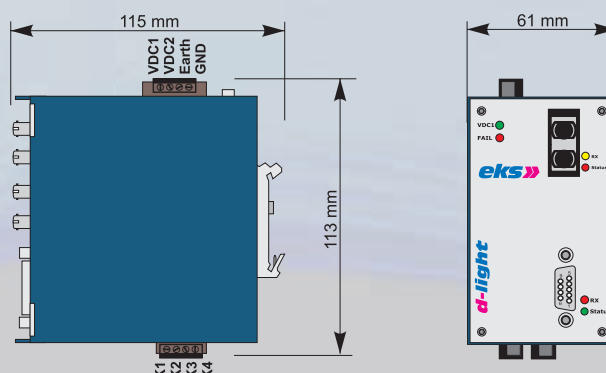

# DL TTY

## TTY-Fiber Optic System

Das DL TTY Übertragungssystem bildet eine asynchrone TTY Schnittstelle ( 20mA aktiv, halbaktiv oder passiv), die halbduplex oder vollduplex betrieben werden kann (siehe untenstehende Anschlussbilder).

LEDs und optional potenzialfreie Kontakte eines Fehlerrelais signalisieren fehlerhafte Zustände.

## TTY-Fiber Optic System

The system DL TTY forms an asynchronous TTY- interface (20mA active, half-active or passive) which can be operated in two ways: either half-duplex or full-duplex (please note the schematics below).

LEDs and potential-free contacts (optional) of a fault detector relay are able to signal defective states.

Empfänger aktiv / Sender passiv  
Receiver active / Transmitter passive

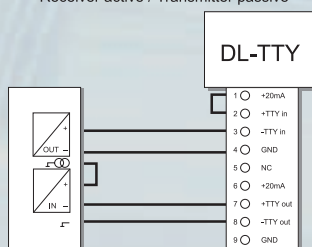

Empfänger passiv / Sender aktiv  
Receiver passive / Transmitter active

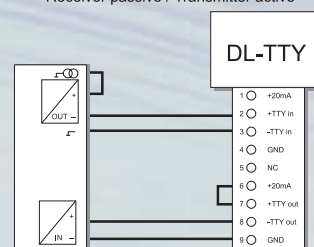

Empfänger passiv / Sender passiv  
Receiver passive / Transmitter passive

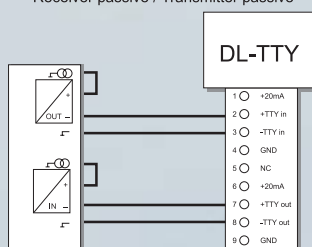

Empfänger aktiv / Sender aktiv  
Receiver active / Transmitter active

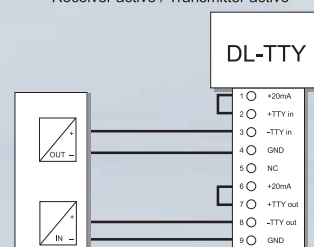

DL-TTY passive

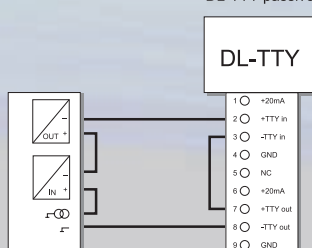

DL-TTY active

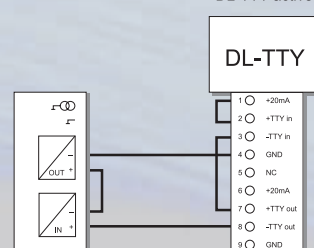

Type	P-ST	P-SMA	MM-ST	MM-SC	MM-SC /BIDI	SM-ST	SM-SC	SM-E2	SM-SC /BIDI
Order no. DLTTY/	0 1000 4101	0 1000 4102	0 1000 4121	0 1000 4123	0 1000 4123 BIDIA 4123-BIDIB	0 1000 4131	0 1000 4133	0 1000 4135	0 1000 4133-BIDIA 4133-BIDIB
FO connector	ST	SMA	ST	SC	SC	ST	SC	E-2000	SC
Fiber	POF or HCS (980/1000 μm) (200/230 μm)		Multimode 62,5 (50) /125 μm			Singlemode 9/125 μm			
Optical budget	12 dB		12 dB			16 dB			
FO range	50 m or 120 m (180dB/km) / (10dB/km)		5 km (1 dB/km)			30 km, others up to 100 km on request (0,3 dB/km)			
Wavelength	650 nm		1310 nm		1310nm 1550nm	1310 nm			1310nm 1550nm
Data rate max.	57,6 KBit/s								
Loop current	2 x 20 mA								
Load	< 100 Ohm								
Operation type	<b>duplex:</b> active, half-active or passive / <b>Half-duplex:</b> active or passive								
Connecting plug	9 pole Sub-D female and 6 pole terminal								
Status - LEDs	Power supply (green) / Data (yellow) / Status (red)								
Operating voltage	12-30 VDC, other voltages on request								
Power consumption	5 Watt, 200 mA (24V)								
Potential separation	500 VDC (24 VDC → TTY)								
Operating temperature	-40°C - +70°C (Multimode and Singlemode with ST or SC) -20°C - +55°C (all others)								
Storage temperature	-40°C - +85°C								
EMC	EN61000-6-2 / EN55022 +A1 + A2 Class B								
Weight	500 g								
Dimensions H x W x D	H: 115mm W: 61mm D: 113mm								
Housing	Stainless steel, powder coated								

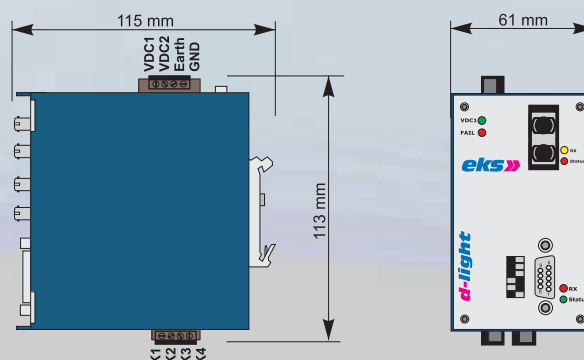

# DL LWV

## Medienkonverter und optische Verstärker

Das LWL-System DL LWV dient der aktiven Kopplung, Verstärkung oder Medienkonvertierung unterschiedlicher LWL-Übertragungsstrecken.

Nicht ausreichende Einkoppelleistungen erfordern eine Zwischenverstärkung, unterschiedliche Faserarten in einer Applikation eine Medienkonvertierung. Das System DL LWV erlaubt die unterschiedlichsten Möglichkeiten.

Die Systeme enthalten LWL-Empfänger- und LWL-Sendebausteine. Das ankommende Signal wird elektrisch aufbereitet und durch den Sender wieder in den Lichtwellenleiter eingekoppelt. Mit Hilfe dieses Zwischenverstärkers ist theoretisch eine unbegrenzte Leitungslänge mit unterschiedlichen Faserarten wie Kunststofffaser-, HCS, Multimode- oder Singlemode-Lichtwellenleitern möglich. LED's und optional potenzialfreie Kontakte eines Fehlerrelais signalisieren fehlerhafte Zustände.

**Bitte beachten Sie, dass die nebenstehende Tabelle nur einen Auszug aus dem Lieferprogramm darstellt. Grundsätzlich ist jegliche Kombination aus Faserart, Wellenlänge und Bandbreite möglich. Die entsprechenden Spalten sind mit F1 bis F16 gekennzeichnet.**

## Media Converter and Optical Amplifier

The fiber optic system DL LWV works as amplifier and media converter for several fiber optic transmission networks.

Less optical power requires amplification. Different fiber types within one application need conversion. The system DL LWV offers various possibilities, corresponding to these requirements.

The system contains fiber optic receiver and transmitter components. The incoming signal is electrically processed and then coupled back into the fiber optic cable via the transmitter. With the aid of this intermediate amplifier the line length is unlimited using various fiber types as for instance: POF, HCS, multimode or singlemode fiber optic cable.

LEDs and potential-free contacts (optional) of a fault detector relay are able to signal defective states.

**Please note that the adjoining chart just covers a small selection of our product range. In general, any combination of fiber type, wavelength and bandwidth is available. The columns are marked with F1 up to F16 for the types of fiber.**



FO interface	F1	F2	F3	F4	F5	F6	F7	F8	F9	F10	F11	F12	F13	F14	F15	F16
FO connector	HP VL	HP VL	ST	SMA	ST	SMA	ST	SC	ST	SC	SC BIDI	E-2000	ST	SC	SC BIDI	E-2000
Fiber	POF 980/1000µm				POF 980/1000µm		Multimode 62,5 (50) /125µm					Singlemode 9/125µm				
Optical budget	29 dB	12 dB	12 dB	12 dB	12 dB		8 (4,2) dB		12 dB			16 dB				
Data rate max.	57,6 KBits	10 MBits	5 MBit/s		100 MBit/s		5 MBit/s		100 MBit/s			100 MBit/s				
FO range	150m	40 m			40 m		2,6 (1,4) km		5 km			30 km, others up to 100 km on request				
Fiber attenuation	180 dB/km						3 dB/km		1 dB/km			0,3 dB/km				
Wavelength	650 nm						820 nm		1310 nm			1310 nm				
Status - LEDs	Power supply (green) / Data (yellow) / Status (red)															
Operating voltage	12-30 VDC, other voltages on request															
Power consumption	5 Watts, 200 mA (24V)															
Potential separation	500 VDC															
Operating temperature	-40°C - +70°C (Multimode and Singlemode with ST or SC) -20°C - +55°C (all others)															
Storage temperature	-40°C - +85°C															
EMC	EN61000-6-2 / EN55022 +A1 + A2 Class B															
Weight	500 g															
Dimensions H x W x D	H: 115mm W: 61mm D: 113mm															
Housing	Stainless steel, powder coated															

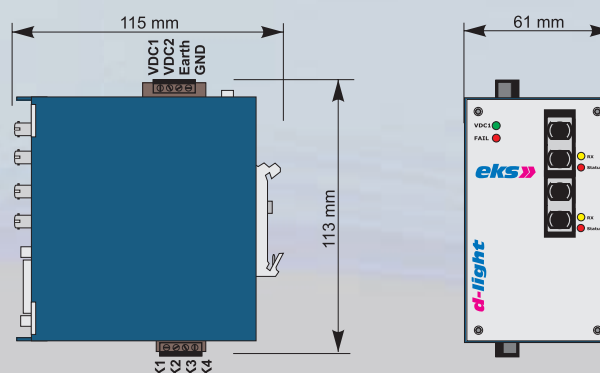

# IOL3000

## Analog- und Schaltsignal Fiber Optic System

Mit dem LWL-System IOL3000 werden Schalt-, Steuer- und Analogsignale über Lichtwellenleiter übertragen.

Bis zu 8 digitale Schaltsignale (12 - 24VDC) und/oder 4 analoge Signale (0-10V oder 0-20mA, die über einen A/D-Wandler mit einer Auflösung von 10 Bit digitalisiert werden), können über einen LWL in einer Punkt-zu-Punkt-Struktur oder Linienstruktur übertragen werden. Am Empfänger werden die digitalisierten Daten dann wieder als Schaltsignal und/oder als Analogdaten ausgegeben.

Durch Zwischenschaltung eines ED-Systems können zusätzliche analoge und digitale Daten aufgenommen werden. Dabei kann bei den digitalen Daten per DIP-Switch gewählt werden, ob eine elektrische ODER-Verknüpfung der elektrisch und optisch empfangenen Daten erfolgt oder die elektrischen Daten die empfangenen optischen Daten überschreiben. Bei den analogen Werten muss per DIP-Switch gewählt werden, ob man entweder die elektrischen oder die optischen Werte überträgt. Die Ausführung kann in einer Linien- oder Ringform als Einfaser-Lösung erfolgen.

LEDs und potenzialfreie Kontakte eines Fehlerrelais signalisieren fehlerhafte Zustände.

## Analog- and Digital-Signal Fiber Optic System

The fiber optic system IOL3000 transmits digital signals (e.g., contact closures, control-signals) and analog signals via fiber optics.

The fiber optic system is able to transmit up to 8 digital signals (12-24VDC) and/or 4 analog signals (0-10V or 0-20mA, digitalized via A/D converter with a resolution of 10 Bit) within a point-to-point structure or line-structure.

The interconnection of an input/pass system (ED) allows the transmission of additional digital and analog data. You can choose if you want to have an electric disjunction (OR) of electrically and optically received data or if the electric data shall overwrite the optical data. In case of analog data the DIP switch must be used to decide whether the optical or the electrical signals shall be transmitted. The devices are available for line or ring structures as one fiber solutions.

LEDs and potential-free contacts of a fault detector relay are able to signal defective states.

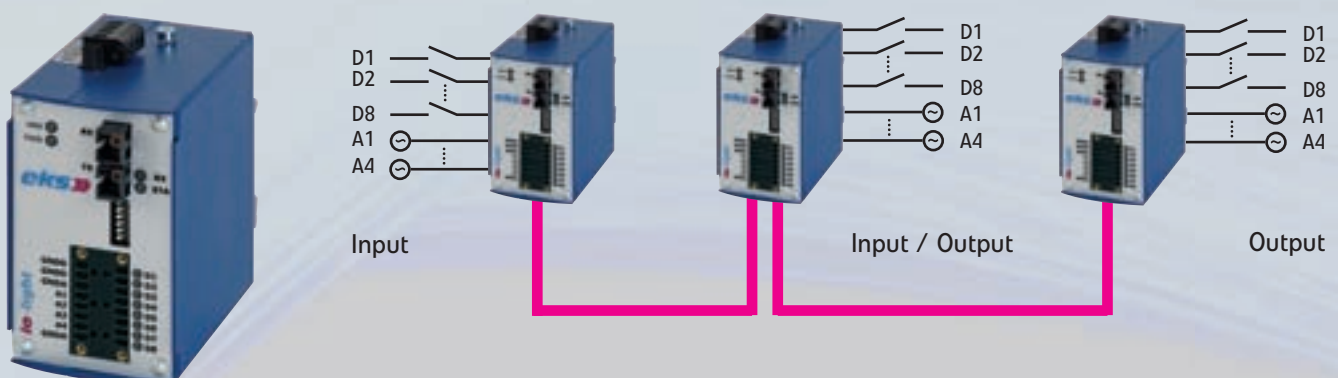

Type	P-ST	P-SMA	MM-ST	MM-SC		SM-ST	SM-SC	SM-E2	
<b>Type</b> Transmitter IOL3000/									
Order no. 4 x Analog 0-10V	0 3000 1101	0 3000 1102	0 3000 1121	0 3000 1123		0 3000 1131	0 3000 1133	0 3000 1135	
Order no. 4 x Analog 0-10 V 8 x Digital 12-24 VDC	0 3000 1201	0 3000 1202	0 3000 1221	0 3000 1223		0 3000 1231	0 3000 1233	0 3000 1235	
Order no. 8 x Digital 12-24 VDC	0 3000 1301	0 3000 1302	0 3000 1321	0 3000 1323		0 3000 1331	0 3000 1333	0 3000 1335	
Order no. 4 x Analog 0-20 mA 8 x Digital 12-24 VDC	0 3000 1401	0 3000 1402	0 3000 1421	0 3000 1423		0 3000 1431	0 3000 1433	0 3000 1435	
Order no. 4 x Analog 0-20 mA	0 3000 1501	0 3000 1502	0 3000 1521	0 3000 1523		0 3000 1531	0 3000 1533	0 3000 1535	
<b>Type</b> Receiver IOL3000/									
Order no. 4 x Analog 0-10V (0,2%)	0 3000 2101	0 3000 2102	0 3000 2121	0 3000 2123		0 3000 2131	0 3000 2133	0 3000 2135	
Order no. 4 x Analog 0-10 V 8 x Digital 12-24 VDC	0 3000 2201	0 3000 2202	0 3000 2221	0 3000 2223		0 3000 2231	0 3000 2233	0 3000 2235	
Order no. 8 x Digital 12-24 VDC	0 3000 2301 (IR)	0 3000 2302 (IR)	0 3000 2321 (IR)	0 3000 2323 (IR)		0 3000 2331 (IR)	0 3000 2333 (IR)	0 3000 2335 (IR)	
Order no. 4 x Analog 0-20 mA (0,2%) 8 x Digital 12-24 VDC	0 3000 2401	0 3000 2402	0 3000 2421	0 3000 2423		0 3000 2431	0 3000 2433	0 3000 2435	
Order no. 4 x Analog 0-20 mA (0,2%)	0 3000 2501	0 3000 2502	0 3000 2521	0 3000 2523		0 3000 2531	0 3000 2533	0 3000 2535	
<b>FO connector</b>	ST	SMA	ST	SC		ST	SC	E-2000	
<b>Fiber</b>	POF or HCS (980/1000 μm) (200/230 μm)		Multimode 62,5 (50) /125 μm			Singlemode 9/125 μm			
<b>Optical budget</b>	12 dB		12 dB			16 dB			
<b>FO range</b>	50 m or 120 m (180dB/km) / (10dB/km)		5 km (1 dB/km)			30 km, others up to 100 km on request (0,3 dB/km)			
<b>Wavelength</b>	650 nm		1310 nm			1310 nm			
<b>Status - LEDs</b>	Power supply (green) / Data-receive (yellow) / Status (red) / Input / Output (green)								
<b>Operating voltage</b>	12-30 VDC, other voltages on request								
<b>Cable length electr.</b>	1 m								
<b>Power consumption</b>	200 mA								
<b>Potential separation</b>	500 VDC								
<b>Operating temperature</b>	-40°C - +70°C (Multimode and Singlemode with ST or SC) -20°C - +55°C (all others)								
<b>Storage temperature</b>	-40°C - +85°C								
<b>EMC</b>	EN61000-6-2 / EN55022 +A1 + A2 Class B								
<b>Failure relay</b>	25VDC (1A) / 60VDC (0,3A)								
<b>Weight</b>	500 g								
<b>Dimensions H x W x D</b>	H: 115mm W: 61mm D: 113mm								
<b>Housing</b>	Stainless steel, powder coated								

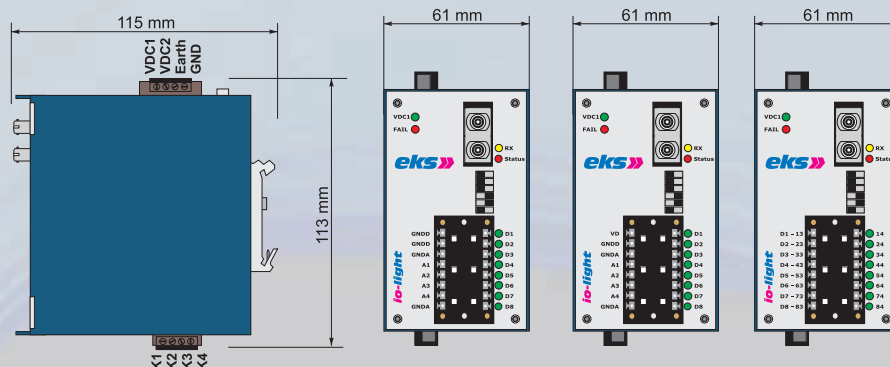

# IOL3100

## Schaltsignal Fiber Optic System, bidirektional

Mit dem LWL-System IOL3100 werden Schalt- oder Steuersignale bidirektional über Lichtwellenleiter übertragen.

Bis zu 4 digitale Schaltsignale (12 - 24VDC) können über einen LWL in einer Punkt-zu-Punkt-Struktur bidirektional übertragen werden. Am Empfänger werden die digitalisierten Daten dann wieder als Schaltsignal ausgegeben.

LEDs und potenzialfreie Kontakte eines Fehlerrelais signalisieren fehlerhafte Zustände.

## Digital-Signal Fiber Optic System, bi-directional

The fiber optic system IOL3100 transmits digital signals (e.g., contact closures, control-signals 12-24VDC) bi-directional via fiber optics.

LEDs and potential-free contacts of a fault detector relay are able to signal defective states.

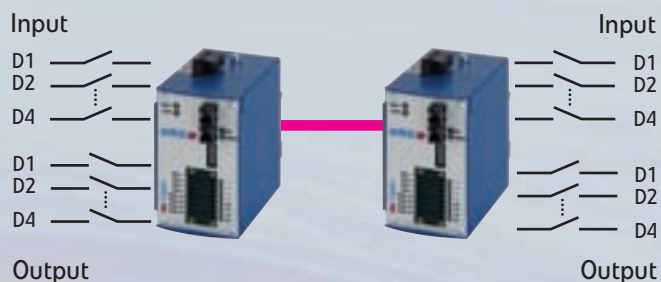



Type	TRX-4D-P-ST	TRX-4D-P-SM	TRX-4D-MM-ST	TRX-4D-MM-SC	TRX-4D-MM-SC /BIDI	TRX-4D-SM-ST	TRX-4D-SM-SC	TRX-4D-SM-E2	TRX-4D-SM-SC /BIDI
Order no. IOL3100/	0 3100 2301	0 3100 2302	0 3100 2321	0 3100 2323	0 3100 2323-BIDIA 2323-BIDIB	0 3100 2331	0 3100 2333	0 3100 2335	0 3100 2333-BIDIA 2333-BIDIB
FO connector	ST	SMA	ST	SC	SC	ST	SC	E-2000	SC
Fiber	POF or HCS (980/1000 μm) (200/230 μm)		Multimode 62,5 (50) /125 μm			Singlemode 9/125 μm			
Optical budget	12 dB		12 dB			16 dB			
FO range	50 m or 120 m (180dB/km) / (10dB/km)		5 km (1 dB/km)			30 km, others up to 100 km on request (0,3 dB/km)			
Wavelength	650 nm		1310 nm		1310 nm 1550 nm	1310 nm			1310 nm 1550 nm
Signal Input	12 – 24 VDC / 5 mA								
Signal Output	30VDC (1A) / 60VDC (0,2A)								
Cable length electr.	1 m								
Connecting plug	16 pole terminal								
Status - LEDs	Power supply (green) / Data (yellow) / Status (red)								
Operating voltage	12-30 VDC, other voltages on request								
Power consumption	200 mA								
Potential separation	500 VDC								
Operating temperature	-40°C - +70°C (Multimode and Singlemode with ST or SC) -20°C - +55°C (all others)								
Storage temperature	-40°C - +85°C								
EMC	EN61000-6-2 / EN55022 +A1 + A2 Class B								
Failure relay	25VDC (1A) / 60VDC (0,3A)								
Weight	500 g								
Dimensions H x W x D	H: 115mm W: 61mm D: 113mm								
Housing	Stainless steel, powder coated								

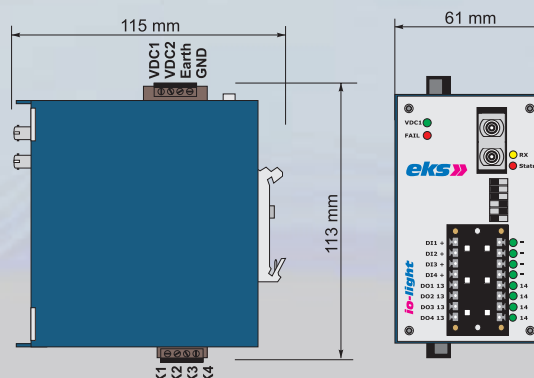

# IOL3200

## Schaltsignal Fiber-Optic-System

Mit dem LWL-System IOL3200 werden Schalt- oder Steuersignale über Lichtwellenleiter übertragen.

Bis zu 12 digitale Schaltsignale (12 - 24VDC) können über einen LWL in einer Punkt-zu-Punkt-Struktur übertragen werden. Am Empfänger werden die digitalisierten Daten dann wieder als Schaltsignal ausgegeben.

Durch Zwischenschaltung eines ED-Systems können zusätzliche digitale Daten aufgenommen werden. Dabei kann gewählt werden, ob eine elektrische ODER-Verknüpfung der elektrisch und optisch empfangenen Daten erfolgt oder die elektrischen Daten die empfangenen optischen Daten überschreiben. Die Ausführung kann in einer Linien- oder Ringform als Einfaser-Lösung erfolgen.

LEDs und potenzialfreie Kontakte eines Fehlerrelais signalisieren fehlerhafte Zustände.

## Digital-Signal Fiber Optic System

The fiber optic system IOL3200 transmits digital signals (e.g., contact closures, control-signals) via fiber optics.

Using adressed subscribers, the fiber optic system is able to transmit up to 12 digital signals (12-24VDC) within a point-to-point structure.

The interconnection of an input/pass system allows the transmission of additional digital data. You can choose if you want to have an electric disjunction (OR) of electrically and optically received data or if the electric data shall overwrite the optical data. The devices are available for line or ring structures as one fiber solutions.

LEDs and potential-free contacts of a fault detector relay are able to signal defective states.

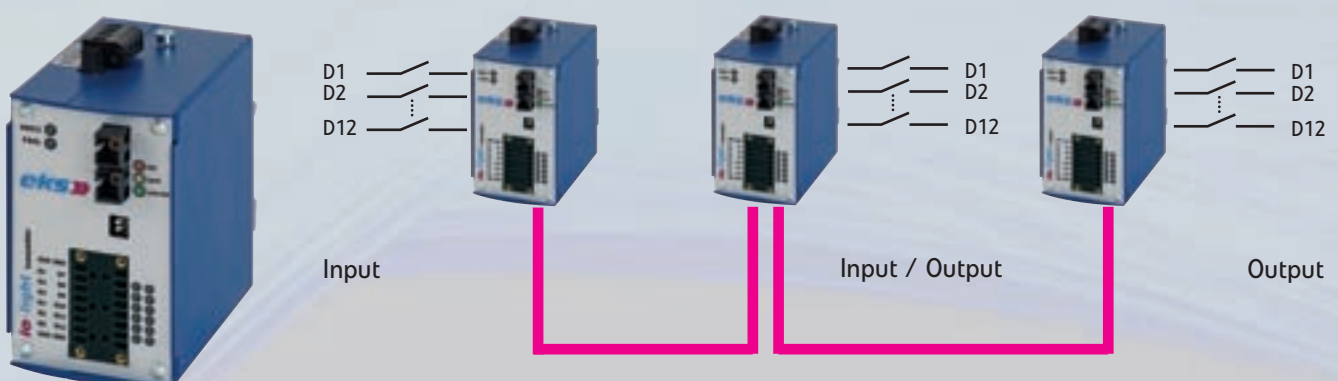

<b>Type</b>	<b>TX-12D-P-ST</b>	<b>TX-12D-P-SM</b>	<b>TX-12D-MM-ST</b>	<b>TX-12D-MM-SC</b>		<b>TX-12D-SM-ST</b>	<b>TX-12D-SM-SC</b>	<b>TX-12D-SM-E2</b>	
<b>Order no. IOL3200/</b>	0 3200 1301	0 3200 1302	0 3200 1321	0 3200 1323		0 3200 1331	0 3200 1333	0 3200 1335	
<b>Type</b>	<b>RX-12D-P-ST</b>	<b>RX-12D-P-SM</b>	<b>RX-12D-MM-ST</b>	<b>RX-12D-MM-SC</b>		<b>RX-12D-SM-ST</b>	<b>RX-12D-SM-SC</b>	<b>RX-12D-SM-E2</b>	
<b>Order no. IOL3200/</b>	0 3200 2301	0 3200 2302	0 3200 2321	0 3200 2323		0 3200 2331	0 3200 2333	0 3200 2335	
<b>FO connector</b>	ST	SMA	ST	SC		ST	SC	E-2000	
<b>Fiber</b>	POF or HCS (980/1000 μm) (200/230 μm)		Multimode 62,5 (50) / 125 μm			Singlemode 9/125 μm			
<b>Optical budget</b>	12 dB		12 dB			16 dB			
<b>FO range</b>	50 m or 120 m (180dB/km) / (10dB/km)		5 km (1 dB/km)			30 km, others up to 100 km on request (0,3 dB/km)			
<b>Wavelength</b>	650 nm		1310 nm		1310 nm 1550 nm	1310 nm		1310 nm 1550 nm	
<b>Signal Input</b>	12 – 24 VDC / 5 mA								
<b>Signal Output</b>	30VDC (1A) / 60VDC (0,2A)								
<b>Cable length electr.</b>	1 m								
<b>Connecting plug</b>	16 pole terminal								
<b>Status - LEDs</b>	Power supply (green) / Failure (red) / FiberView (red, yellow, green)								
<b>Operating voltage</b>	12-30 VDC, other voltages on request								
<b>Power consumption</b>	200 mA								
<b>Potential separation</b>	500 VDC								
<b>Operating temperature</b>	-40°C - +70°C (Multimode and Singlemode with ST or SC) -20°C - +55°C (all others)								
<b>Storage temperature</b>	-40°C - +85°C								
<b>EMC</b>	EN61000-6-2 / EN55022 +A1 + A2 Class B								
<b>Failure relay</b>	25VDC (1A) / 60VDC (0,3A)								
<b>Weight</b>	500 g								
<b>Dimensions H x W x D</b>	H: 115mm W: 61mm D: 113mm								
<b>Housing</b>	Stainless steel, powder coated								

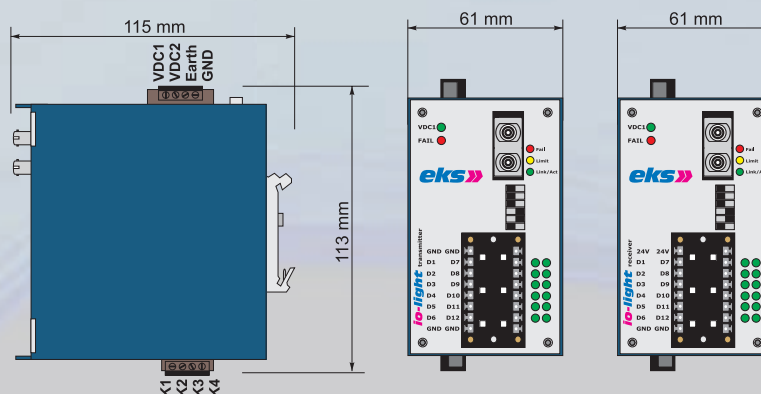

# IOL3300

## Schaltsignal Fiber-Optic-System

Mit dem LWL-System IOL3300 werden Schalt- oder Steuersignale über Lichtwellenleiter übertragen.

Ein digitales Schaltsignal (12 - 24VDC) kann über eine oder zwei LWL-Fasern bidirektional übertragen werden. Am Empfänger wird das digitalisierte Signal dann wieder als Schaltsignal über einen potenzialfreien Relaiskontakt ausgegeben.

LEDs und potenzialfreie Kontakte eines Fehlerrelais signalisieren fehlerhafte Zustände.

## Digital-Signal Fiber Optic System

The fiber optic system IOL3300 transmits digital signals (e.g., contact closures, control-signals) via fiber optics.

The fiber optic cable is able to transmit one digital signal (12-24VDC) in both directions via one or two fiber.

LEDs and potential-free contacts of a fault detector relay are able to signal defective states.

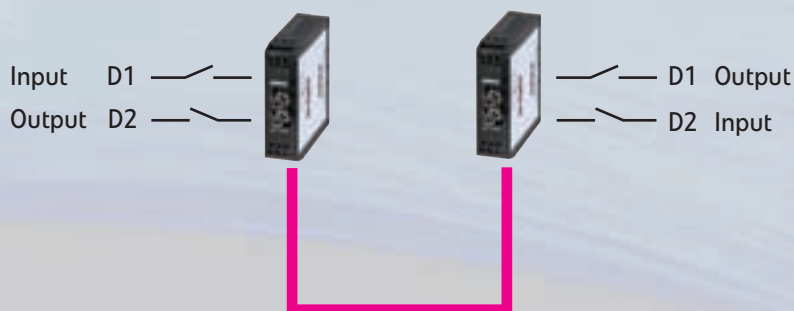

Type	TRX-1D-P-ST	TRX-1D-P-SM	TRX-1D-MM-ST	TRX-1D-MM-SC	TRX-1D-MM-SC BIDI	TRX-1D-SM-ST	TRX-1D-SM-SC	TRX-1D-SM-E2	TRX-1D-SM-SC BIDI
Order no. IOL3300/	0 3300 2301IR	0 3300 2302IR	0 3300 2321	0 3300 2323	0 3300 2323-BIDIA IR 2323-BIDIB IR	0 3300 2331	0 3300 2333	0 3300 2335	0 3300 2333-BIDIA IR 2333-BIDIB IR
FO connector	ST	SMA	ST	SC	SC	ST	SC	E-2000	SC
Fiber	POF or HCS (980/1000 μm) (200/230 μm)		Multimode 62,5 (50) /125 μm			Singlemode 9/125 μm			
Optical budget	12 dB		12 dB			16 dB			
FO range	50 m or 120 m (180dB/km) / (10dB/km)		5 km (1 dB/km)			30 km, others up to 100 km on request (0,3 dB/km)			
Wavelength	650 nm		1310 nm		1310 nm 1550 nm	1310 nm			1310 nm 1550 nm
Signal Input	10 – 30 VDC / 5 mA								
Signal Output	24VAC (1A) / 24VDC (1A) / 60VDC (0,3A)								
Cable length electr.	1 m								
Failure relay	24VDC (1A) / 60VDC (0,3A)								
Status - LEDs	Power supply (green) / Status (red) / Data (yellow)								
Operating voltage	12-30 VDC								
Power consumption	100 mA								
Operating temperature	-40°C - +70°C (Multimode and Singlemode with ST or SC) -20°C - +55°C (all others)								
Storage temperature	-40°C - +85°C								
EMC	EN61000-6-2 / EN55022 +A1 + A2 Class B								
Weight	150 g								
Dimensions H x W x D	H: 82mm W: 93mm D: 22,5mm								
Housing	Polyamid, black								



# DragonLine Switch Unmanaged

## 5x10/100/1000TX und 8x10/100/1000TX



IEEE Standard	IEEE802.3 10Base-T IEEE802.3u 100Base-TX IEEE802.3ab 1000Base-T IEEE802.3x Flow Control and Back Pressure
Switch Architecture	Back-plane (Switching Fabric): 10Gbps Packet throughput ability (Full-Duplex): 14.88Mpps @64bytes
Transfer Rate	14,880pps for Ethernet port 148,800pps for Fast Ethernet port 1,488,000pps for Gigabit Fiber Ethernet port
Memory Buffer	136Kbits
MAC Address	8K MAC address table
Jumbo Frame	9Kbytes
Connector	10/100/1000T: 5 x RJ-45/8xRJ-45
Network Cable	10Base-T: 2-pair UTP/STP Cat. 3, 4, 5 cable EIA/TIA-568 100-Ohm (100m) 100Base-TX: 2-pair UTP/STP Cat. 5 cable EIA/TIA-568 100-Ohm (100m)
Protocol	CSMA/CD
LED	Per unit: Power 1 (Green), Power 2 (Green), Fault(Red) Per port: Link/Activity (Green), Speed (1000Mbps Green)
Power Supply	DC 12V - 48V / AC 18V – 30V Redundant power with polarity reverse protect function and removable terminal block
Power Consumption	4.6 Watt / 7,79 Watt
Operating Humidity	5%~95% (Non-condensing)
Operating Temperature	Wide Operating Temperature -40°C ~ +75°C
Storage Temperature	-40°C~85°C
Case Dimension	Metal case. IP-30, 30mm (W) x 95mm (D) x 140mm (H)
Installation	DIN Rail and Wall Mount Design
EMI	FCC Class A, CE EN61000-4-2 (ESD), CE EN61000-4-3 (RS), CE EN-61000-4-4 (EFT), CE EN61000-4-5 (Surge), CE EN61000-4-6 (CS), CE EN61000-4-8, CE EN61000-4-11, CE EN61000-4-12, CE EN61000-6-2, CE EN61000-6-4
Safety	UL, cUL, CE/EN60950-1
Stability Testing	IEC60068-2-32 (Free fall), IEC60068-2-27 (Shock), IEC60068-2-6 (Vibration)

Part Number	Description
261670100E	5x10/100/1000TX -40°C ~ +75°C
261870200A2E	8x10/100/1000TX -40°C ~ +75°C

# DragonLine Switch Unmanaged

## 4x10/100/1000TX + 1x1000SFP



IEEE Standard	IEEE802.3 10Base-T Ethernet IEEE802.3u 100Base-TX IEEE802.3ab 1000Base-T IEEE802.3x Flow Control and Back Pressure IEEE8.2.3z 1000Base FX
Switch Architecture	Back-plane (Switching Fabric): 10Gbps Packet throughput ability (Full-Duplex): 14.88Mpps @64bytes
Transfer Rate	14,880pps for Ethernet port 148,800pps for Fast Ethernet port 1,488,000pps for Gigabit Fiber Ethernet port
Memory Buffer	136Kbits
MAC Address	8K MAC address table
Jumbo Frame	9Kbytes
Connector	10/100/1000T: 4 x RJ-45 Mini-GBIC: 1 x SFP socket
Network Cable	10Base-T: 2-pair UTP/STP Cat. 3, 4, 5 cable / EIA/TIA-568 100-Ohm (100m) 100Base-TX: 2-pair UTP/STP Cat. 5 cable / EIA/TIA-568 100-Ohm (100m)
Optical Cable	Multimode: 50/125µm~62.5/125µm Singlemode: 9/125µm
Protocol	CSMA/CD
LED	Per unit: Power 1 (Green), Power 2 (Green), Fault(Red) Per port: Link/Activity (Green), Speed (1000Mbps Green) SFP: Link/Activity (Green)
Power Supply	DC 12~48V Redundant power with polarity reverse protect function and removable terminal block
Power Consumption	5.50 Watt
Operating Humidity	5%~95% (Non-condensing)
Operating Temperature	Wide Operating Temperature -40°C ~ +75°C
Storage Temperature	-40°C~85°C
Case Dimension	Metal case. IP-30, 30mm (W) x 95mm (D) x 140mm (H)
Installation	DIN Rail and Wall Mount Design
EMI	FCC Class A, CE EN61000-4-2 (ESD), CE EN61000-4-3 (RS), CE EN-61000-4-4 (EFT), CE EN61000-4-5 (Surge), CE EN61000-4-6 (CS), CE EN61000-4-8, CE EN61000-4-11, CE EN61000-4-12, CE EN61000-6-2, CE EN61000-6-4
Safety	UL, cUL, CE/EN60950-1
Stability Testing	IEC60068-2-32 (Free fall), IEC60068-2-27 (Shock), IEC60068-2-6 (Vibration)

Part Number	Description
261470200E	4x10/100/1000T + 1x1000SFP -40°C ~ +75°C

# DragonLine Switch Managed

7x10/100TX + COMBO: 3x10/100/1000T + 3x100/1000 SFP



IEEE Standard	IEEE802.3 10Base-T Ethernet / IEEE802.3u 100Base-TX / IEEE802.1ab LLDP IEEE802.3ab 1000Base-T / IEEE802.3z Gigabit fiber / IEEE802.1p Class of Service IEEE802.3x Flow Control and Back Pressure / IEEE802.3ad Port trunk with LACP IEEE802.1d Spanning Tree/ IEEE802.1w Rapid Spanning Tree / IEEE802.1Q VLAN Tag IEEE802.1x User Authentication (Radius)
Switch Architecture	Back-plane (Switching Fabric): 7.4Gbps Packet throughput ability(Full-Duplex): 11Mpps @64bytes
Transfer Rate	14,880pps for Ethernet port 148,800pps for Fast Ethernet port 1,488,000pps for Gigabit Fiber Ethernet port
Packet Buffer	1Mbits
Mac Address	8K MAC address table
Connector	10/100TX: 7 x RJ-45 10/100/1000T/ Mini-GBIC Combo: 3 x RJ-45 + 3 x 100/1000 SFP sockets RS-232 connector: RJ-45 type
DI/DO	2 Digital Input (DI) : Level 0 : -30~2V Level 1 : 10~30V Max. input current:8mA 2 Digital Output(DO): Open collector to 40 VDC, 200mA
Network Cable	10Base-T: 2-pair UTP/STP Cat. 3, 4, 5 cable / EIA/TIA-568 100-Ohm (100m) 100Base-TX: 2-pair UTP/STP Cat. 5/5E cable / EIA/TIA-568 100-Ohm (100m) 1000Base-TX: 2-pair UTP/STP Cat. 5e or 6 cable / EIA/TIA-568 100-Ohm (100m)
Optical Fiber	Multimode: 50/125μm~62.5/125μm Singlemode: 9/125μm
Protocol	CSMA/CD
LED	Per unit: Power (Green), Power 1 (Green), Power 2 (Green), Fault (Red), Master (Green) 10/100TX : Link/Activity (Green), Full duplex/Collision (Yellow) Giga Copper: Link/Activity (Green), Speed (1000Mbps Green) SFP: Link/Activity (Green)
Power Supply	12~48 VDC Redundant power with polarity reverse protect function and removable terminal block
Power Consumption	10.2 Watt (Open issue)
Operating Humidity	5% to 95% (Non-condensing)
Operating Temperature	Standard -10°C~60°C / Wide Operating Temperature -40°C ~ +75°C
Storage Temperature	-40°C to 85°C
Case Dimension	Metal case. IP-30, 72mm (W) x 105mm (D) x 152mm (H)
Installation	DIN Rail and Wall Mount Design
EMI	FCC Class A, CE EN61000-4-2 (ESD), CE EN61000-4-3 (RS), CE EN-61000-4-4 (EFT), CE EN61000-4-5 (Surge), CE EN61000-4-6 (CS), CE EN61000-4-8, CE EN61000-6-2, CE EN61000-6-4
Safety	UL, cUL, CE/EN60950-1
Stability Testing	IEC60068-2-32 (Free fall), IEC60068-2-27 (Shock), IEC60068-2-6 (Vibration)



Management	SNMP v1 v2c, v3/ Web/Telnet/CLI/NS-View Management
SNMP MIB	RFC 1215 Trap, RFC1213 MIBII, RFC 1157 SNMP MIB, RFC 1493 Bridge MIB, RFC 2674 VLAN MIB, RFC 1643 , RFC 1757, RSTP MIB, Private MIB
VLAN	Port Based VLAN IEEE802.1Q Tag VLAN (256 entries)/ VLAN ID (Up to 4K, VLAN ID can be assigned from 1 to 4096.) GVRP (256 Groups)
Port Trunk with LACP	LACP Port Trunk: 4 Trunk groups/Maximum 4 trunk members
LLDP	Support LLDP to allow switch to advise its identification and capability on the LAN
Spanning Tree	Support IEEE802.1w Rapid Spanning Tree
Ring	Support Ring, Dual Homing, Couple Ring and Dual Ring Topology Provide redundant backup feature and the recovery time below 20ms.
Quality of Service	The quality of service determined by port, Tag and IPv4 Type of service, IPv4/IPv6 Different Service,
Class of Service	Support IEEE802.1p class of service, per port provides 4 priority queues
Port Security	Support 100 entries of MAC address for static MAC and another 100 for MAC filter
Port Mirror	Support 3 mirroring types: "RX, TX and Both packet".
IGMP	Support IGMP snooping v1,v2 256 multicast groups and IGMP query Support multicast filter
IP Security	Support 10 IP addresses that have permission to access the switch management and to prevent unauthorized intruder.
Login Security	Support IEEE802.1X Authentication/RADIUS
Bandwidth Control	Support ingress packet filter and egress packet limit The egress rate control supports all of packet type and the limit rates are 100K~250Mbps Ingress filter packet type combination rules are Broadcast/Multicast/Unknown Unicast packet, Broadcast/Multicast packet, Broadcast packet only and all of packet. The packet filter rate can be set from 100k to 250Mbps,
Flow Control	Support Flow Control for Full-duplex and Back Pressure for Half-duplex
System Log	Support System log record and remote system log server
SMTP	Support SMTP Server and 6 e-mail accounts for receiving event alert
Relay Alarm	Provides one relay output for port breakdown, power fail Alarm Relay current carry ability: 1A @ DC24V
DIDO	DO: When disconnection of the specific port was detected, DO will activate the signal LED to alarm. DI: Integrate critical sensors: 2 groups of digital inputs. DI can integrate the sensors into the auto alarm system and transfer the alarm information to IP network with email and SNMP.
SNMP Trap	Supports up to 3 trap receivers Supported traps: Cold start, Port link up, Port link down, Authentication Failure, Private Trap for power status, Port Alarm configuration, Fault alarm, Ring topology change
DHCP	Provide DHCP Client, DHCP Server and IP Relay
DNS	Provide DNS client feature and support Primary and Secondary DNS server
SNTP	Support SNTP to synchronize system clock in Internet
Firmware Update, configuration backup and restore	Support TFTP firmware update, System configure backup and restore.
ifAlias	Each port allows importing 128bit of alphabetic string of word on SNMP and CLI interface.

\*\* Optional

Part Number	Description
261770300E	Industrial Ethernet Switch (Managed / Ring) -40°C ~ +75°C

# DragonLine Switch Managed

16x10/100TX + COMBO: 2x10/100/1000T + 2x100/1000 SFP



IEEE Standard	IEEE802.3 10Base-T Ethernet / IEEE802.3u 100Base-TX / IEEE802.3ab 1000Base-T IEEE802.3z Gigabit fiber / IEEE802.3x Flow Control and Back Pressure IEEE802.3ad Port trunk with LACP / IEEE802.1x User Authentication (Radius) IEEE802.1d Spanning Tree/ IEEE802.1w Rapid Spanning Tree / IEEE802.1Q VLAN Tag IEEE802.1p Class of Service / IEEE802.1ab LLDP
Switch Architecture	Back-plane (Switching Fabric): 7.2Gbps Packet throughput ability(Full-Duplex): 10.7Mpps @64bytes
Transfer Rate	14,880pps for Ethernet port 148,800pps for Fast Ethernet port 1,488,000pps for Gigabit Fiber Ethernet port
Packet Buffer	1Mbits
Mac Address	8K MAC address table
Flash ROM	4Mbytes
DRAM	32Mbytes
Connector	10/100TX: 16 x RJ-45 10/100/1000T/ Mini-GBIC Combo: 2 x RJ-45 + 2 x 100/1000 SFP sockets RS-232 connector: RJ-45 type
Network Cable	10Base-T: 2-pair UTP/STP Cat. 3, 4, 5 cable / EIA/TIA-568 100-Ohm (100m) 100Base-TX: 2-pair UTP/STP Cat. 5/5E cable / EIA/TIA-568 100-Ohm (100m)
Optical Cable	Multimode: 50/125µm~62.5/125µm Singlemode: 9/125µm
Protocol	CSMA/CD
LED	Per unit: Power (Green), Power 1 (Green), Power 2 (Green), Fault (Red), Master (Green) 16 10/100TX : Link/Activity (Green), Full duplex/Collision (Yellow) Giga Copper: Link/Activity (Green), Speed (1000Mbps Green) SFP: Link/Activity (Green)
Power Supply	DC 12~48V Redundant power with polarity reverse protect function and removable terminal block
Power Consumption	11.5Watt max.
Operating Humidity	5% to 95% (Non-condensing)
Operating Temperature	Wide Operating Temperature -40°C ~ +75°C
Storage Temperature	-40°C to 85°C
Case Dimension	Metal case. IP-30, 72mm (W) x 105mm (D) x 152mm (H)
Installation	DIN Rail and Wall Mount Design
EMI	FCC Class A, CE EN61000-4-2 (ESD), CE EN61000-4-3 (RS), CE EN-61000-4-4 (EFT), CE EN61000-4-5 (Surge), CE EN61000-4-6 (CS), CE EN61000-4-8, CE EN61000-4-11, CE EN61000-4-12, CE EN61000-6-2, CE EN61000-6-4
Safety	UL, cUL, CE/EN60950-1
Stability Testing	IEC60068-2-32 (Free fall), IEC60068-2-27 (Shock), IEC60068-2-6 (Vibration)

Management	SNMP v1 v2c, v3/ Web/Telnet/CLI/NS-View Management
SNMP MIB	RFC 1215 Trap, RFC1213 MIBII, RFC 1157 SNMP MIB, RFC 1493 Bridge MIB, RFC 2674 VLAN MIB, RFC 1643 , RFC 1757, RSTP MIB, Private MIB
VLAN	Port Based VLAN IEEE802.1Q Tag VLAN (256 entries)/ VLAN ID (Up to 4K, VLAN ID can be assigned from 1 to 4096.)GVRP (256 Groups)
Port Trunk with LACP	LACP Port Trunk: 4 Trunk groups/Maximum 4 trunk members
LLDP	Support LLDP to allow switch to advise its identification and capability on the LAN
Spanning Tree	Support IEEE802.1w Rapid Spanning Tree
Ring	Support Ring, Dual Homing, Couple Ring and Central Ring Topology. Provide redundant backup feature and the recovery time below 20ms. Central Ring can handle up to 4 rings by configuring a single switch only as the Ring Master switch.
Quality of Service	The quality of service determined by port, Tag and IPv4 Type of service, IPv4/IPv6 Different Service
Class of Service	Support IEEE802.1p class of service, per port provides 4 priority queues
Port Security	Support 100 entries of MAC address for static MAC and another 100 for MAC filter
Port Mirror	Support 3 mirroring types: "RX, TX and Both packet".
IGMP	Support IGMP snooping v1,v2 256 multicast groups and IGMP query Support multicast filter
IP Security	Support 10 IP addresses that have permission to access the switch management and to prevent unauthorized intruder.
Login Security	Support IEEE802.1X Authentication/RADIUS
Bandwidth Control	Support ingress packet filter and egress packet limit The egress rate control supports all of packet type and the limit rates are 100K~250Mbps Ingress filter packet type combination rules are Broadcast/Multicast/Unknown Unicast packet, Broadcast/Multicast packet, Broadcast packet only and all of packet. The packet filter rate can be set from 100k to 250Mbps
Flow Control	Support Flow Control for Full-duplex and Back Pressure for Half-duplex
System Log	Support System log record and remote system log server
SMTP	Support SMTP Server and 6 e-mail accounts for receiving event alert
Relay Alarm	Provides one relay output for port breakdown, power fail Alarm Relay current carry ability: 1A @ DC24V
SNMP Trap	Up to 3 Trap stations Cold start, Port link up, Port link down, Authentication Failure, Private Trap for power status, Port Alarm configuration, Fault alarm, Ring topology change
DHCP	Provide DHCP Client/ DHCP Server functions
DNS	Provide DNS client feature and support Primary and Secondary DNS server
SNTP	Support SNTP to synchronize system clock in Internet
Firmware Update	Support TFTP firmware update, TFTP backup and restore.
Configuration upload and download	Support binary configuration file for system quick installation
ifAlias	Each port allows importing 128bit of alphabetic string of word on SNMP and CLI interface.

\* Future release

\*\* Optional

Part Number	Description
26970300E	16x10/100TX + 2x10/100/1000T/ Mini-GBIC Combo -40°C ~ +75°C

# DragonLine POE Switch Unmanaged

## 4x10/100TX POE + 1x10/100TX



IEEE Standard	IEEE802.3 10Base-T Ethernet / IEEE802.3u 100Base-TX Fast Ethernet IEEE802.3x Flow Control and Back Pressure / IEEE802.3af Power over Ethernet
Switch Architecture	Back-plane (Switching Fabric): 1.0Gbps Packet throughput ability (Full-Duplex): 1.488Mpps @64bytes
Transfer Rate	14,880pps for Ethernet port 148,800pps for Fast Ethernet port
Memory Buffer	448Kbits
MAC Address	2K
Connector	10/100TX: 5 x RJ-45 with auto MDI/MDI-X function; Support 4 PoE injector function
PoE pin assignment	RJ-45 port # 1~# 4 support IEEE802.3af End-point, Alternative A mode. Positive (VCC+): RJ-45 pin 1, 2. Negative (VCC-): RJ-45 pin 3, 6. Data (1,2,3,6)
Network Cable	10Base-T: 2-pair UTP/STP Cat. 3, 4, 5 cable / EIA/TIA-568 100-Ohm (100m) 100Base-TX: 2-pair UTP/STP Cat. 5 cable / EIA/TIA-568 100-Ohm (100m)
Protocol	CSMA/CD
LED	Per unit: Power 1 (Green), Power 2 (Green), Fault(Red) Per port: Link/Activity (Green), Full duplex/Collision (Yellow) PoE: Feeding Power (Green)
Power Supply	DC 48V Redundant Power
Power Consumption	3.4Watts (without PoE); 57Watts (Full load with PoE)
Operating Humidity	5%~95% (Non-condensing)
Operating Temperature	Wide Operating Temperature: -40°C ~ +75°C
Storage Temperature	-40°C~85°C
Case Dimension	Metal case. IP-30, 30mm (W) x 95mm (D) x 140mm (H)
Installation	DIN Rail and Wall Mount Design
EMI	FCC Class A, CE EN61000-4-2 (ESD), CE EN61000-4-3 (RS), CE EN-61000-4-4 (EFT), CE EN61000-4-5 (Surge), CE EN61000-4-6 (CS), CE EN61000-4-8, CE EN61000-4-11, CE EN61000-6-2, CE EN61000-6-4
Safety	UL, cUL, CE/EN60950-1
Stability Testing	IEC60068-2-32 (Free fall), IEC60068-2-27 (Shock), IEC60068-2-6 (Vibration)

Part Number	Description
26P670100E	4x10/100TX w/ 4 PoE Injector + 1x10/100TX -40°C ~ +75°C

# DragonLine VDSL Extender

## Ethernet - VDSL2 Extender (RJ45 or COAX)



IEEE Standard	IEEE802.3 / IEEE802.3u
IUT Standard	G.993.1 (VDSL) / G.997.1 compatible
Performance	Full VDSL2 bandwidth up to: (Down Stream / Up Stream) - 200m -> 88 / 49Mbps - 400m -> 63 / 29Mbps - 600m -> 46 / 18Mbps - 800m -> 30 / 5.7Mbps - 1000m -> 22 / 5.3Mbps - 1500m -> 18 / 0.8Mbps - 2000m -> 9 / 0.5Mbps
Connector	10/100TX: RJ-45 x 1 26V000100E: VDSL Twisted Pair RJ-45 x 1 with female Phone Jack 26V000200E VDSL Coaxial Port 1x BNC
DIP Switch	DIP 1: Master, Slave Switch DIP 2: Impulse noise Protection DIP 3: Rate Limit control DIP 4: General Protection
LED	Per unit: Power1(Green) Power2(Green) Power-Fail(Red) 10/100TX: LNK/ACT(Green) VDSL: LNK/ACT(Green)
Power Supply	AC 24V DC 12~48V, Redundant power with polarity reverse protect and removable terminal block
Relay Alarm	1A @ DC24V
Operating Humidity	5%~95% (Non-condensing)
Operating Temperature	-40°C ~ +75°C
Storage Temperature	-40°C~85°C
Case Dimension	Metal case. IP-30, 30 x 140 x 95 mm
Installation	DIN Rail and Wall Mount Design
EMC	CE, FCC Class A EN61000-6-4../ EN61000-6-2 / EN61000-4-2 (ESD) / EN61000-4-3 (Radiated RFI) EN61000-4-4 (Burst) / EN61000-4-5 (Surge) / EN61000-4-6 (Induced RFI) EN61000-4-8 (Magnetic Field) / EN61000-4-11 (Voltage Dip) EN61000-3-2 (Harmonics Current) / EN61000-3-3 (Voltage Fluctuation & Flickers)
Safety	UL508, Class 1/ Division 2
Shock	IEC60068-2-27
Freefall	IEC60068-2-32
Vibration	IEC60068-2-6

Part Number	Description
26V000100E	1x10/100TX / 1xVDSL RJ45 / Industrial Ethernet to VDSL2 Extender -40°C ~ +75°C
26V000200E	1x10/100TX / 1xVDSL COAX / Industrial Ethernet to VDSL2 Extender -40°C ~ +75°C

# FIMP

## Industrielle Kompakt-Spleißbox

Mit 115mm x 61mm x 113mm baut die Industrie-Spleißbox FIMP wesentlich kompakter als vergleichbare 19"-Lösungen. Auch die „inneren Werte“ überzeugen im Hinblick auf eine zeitsparende, einfache Installation. FIMP ist spleißfertig bestückt und integriert Spleißkamm, Spleißablage, Kupplungen, Pigtails sowie die Kabelverschraubung.

Als Kupplungsvarianten stehen SMA, ST, SC, LC, FC-PC, SC-RJ und E-2000 zur Verfügung. Zum Spleißen lässt sich sowohl die Frontplatte als auch die Spleißkassette vollständig herausnehmen, wobei sich die magnetisierbare Spleißkassette problemlos an einem Spleißgerät fixieren lässt. Für Spleißgeräte mit Dorn ist ein passendes Loch in der Kassette vorgesehen.

Das pulverbeschichtete Edelstahlgehäuse ist ebenfalls magnetisierbar, sodass man den Spleißverteiler an einen Schaltschrank oder ein Gehäuse befestigen kann, falls keine Ablagemöglichkeit vorhanden ist. Darüber hinaus verfügt FIMP über einen Clip zur Montage auf eine 35mm-Hutschiene. Auch ein Kit für die Wandmontage ist erhältlich. Somit ergeben sich für den Anwender bei der Montage der platzsparenden Industrie-Lösung hochgradig flexible Befestigungsmöglichkeiten und Vorteile.

## Industrial Compact Splice Box

With 115mm x 61mm x 113mm, our industrial splice box is by far smaller than comparable 19" solutions. Its inner values are really convincing as well so that the installation is quite simple and done very fast. FIMP is ready for splicing and contains splice tray, couplings, pigtails and cable gland. Regarding different couplings, you can choose from SMA, ST, SC, LC, FC-PC, SC-RJ and E-2000. The front panel and the splice cassette can be removed for splicing and since the cassette is magnetizable, it can easily be fixed onto a splice unit. The cassette has got a hole for splice units with a bolt.

The powder coated stainless steel housing is also magnetizable so that the splice box can easily be affixed to another housing or to a switch cabinet in case of no different tray. Furthermore, FIMP has got a clip for DIN rail mounting (35mm) and optional a kit for wall fastening. Thus, there are space-saving and flexible solutions for mounting our FIMP.



FIMP-19

<b>Type MM</b>	<b>6xST Duplex 62MM</b>	<b>6xSC Duplex 62MM</b>	<b>3xLC Quattro 62MM</b>	<b>6xE2000 Duplex 62MM</b>	<b>6xST Duplex 50MM</b>	<b>6xSC Duplex 50MM</b>	<b>3xLC Quattro 50MM</b>	<b>6xE2000 Duplex 50MM</b>	
<b>Order-no.</b>	<b>06000 22196-00</b>	<b>06000 22396-00</b>	<b>06000 22493-00</b>	<b>06000 22596-00</b>	<b>06000 12196-00</b>	<b>06000 12396-00</b>	<b>06000 12493-00</b>	<b>06000 12596-00</b>	
<b>Type SM</b>	<b>6xST Duplex</b>	<b>6xSC Duplex</b>	<b>6xSC 8° APC Duplex</b>	<b>3xLC Quattro</b>	<b>6xE2000 Duplex</b>	<b>6xE2000 8° APC Duplex</b>			
<b>Order-no.</b>	<b>06000 36196-00</b>	<b>06000 36396-00</b>	<b>06000 38396-00</b>	<b>06000 36493-00</b>	<b>06000 36596-00</b>	<b>06000 38596-00</b>			
<b>Weight</b>	450 g								
<b>Dimensions H x W x D</b>	H: 115mm W: 61mm D: 113mm								
<b>Operating temperature</b>	-40°C - +75°C								
<b>Relative humidity</b>	10% - 95% not condensing								
<b>Housing</b>	Stainless steel, powder coated								
<b>Accessories</b>	Order-No.	Description							
	0600E90001	Cable gland M20							
	0600E90002	Locknut M20							
	0600E90003	Strain relief							
	0600E90004	Dummy panel SC duplex							
	0600E90005	Dummy panel Smarthole							
	0600E90006	Dummy panel SC-RJ							
	0600E90007	Splice holder							
	0600E90008	Splice protection							
	0600E90009	Cable tie							
	0600E90010	Labeling strip							
	0600E90011	Screws							
	0600E90013	Dual Mount Kit							
	0600E90014	Tapping screw (metal)							
	0600E90015	Protecting cap							
	0600E90016	Mounting angle for protecting cap							

0600 0 0 23 0 0 00

Front panel	Type	Fiber type	Coupling / Grinding	Assembly	Number	Colour
0600 SC	0-Standard	0-none	20 50/62,5µm ST/ST - Polymer	0- without, only housing	1 to 6	00 - magenta
0601 E2000 Compact	1-Special	1- MM 50µm	21 50/62,5µm ST/SC - Polymer	1- cable gland etc.		01 - blue
0602 Snap-In		2- MM 62.5µm	23 50/62,5µm SC/SC - Polymer	2- only couplings		
0603 1x Smart-Hole		3- SM 9µm	24 50/62,5µm LC-Quattro	9- complete, couplings+pigtails		
0604 2x Smart-Hole		4- POF	25 50/62,5µm E2000/LowProfile			
		5- HCS	28 50/62,5µm E2000/LAN/LowProfile			
		6- MM 50µm OM3	29 50/62,5µm E2000/LAN/Compact			
			30 50/62,5µm E2000/Compact			
			60 9µm/0° ST/ST/0°			
			61 9µm/0° ST/SC/0°			
			62 9µm/0° ST/SC/0° Metal			
			63 9µm/0° SC/SC/0° - Metal			
			64 9µm/0° LC-Quattro 0°			
			65 9µm/0° E2000/0°/LowProfile			
			70 9µm/0° SC/SC/0° - Polymer (blue)			
			80 9µm/8° ST/ST/8°			
			81 9µm/8° ST/SC/8°			
			83 9µm/8° SC/SC/8° - Metal			
			84 9µm/8° LC-Quattro 8° APC			
			85 9µm/8° E2000/8°/LowProfile			

others on request

# FIMP-S

## Industrielle Kompakt-Spleißbox

Mit 120mm x 32mm x 120mm baut die Industrie-Spleißbox FIMP-S wesentlich kompakter als vergleichbare 19"-Lösungen, und ist nur halb so breit wie der FIMP. Auch die „inneren Werte“ überzeugen im Hinblick auf eine zeitsparende, einfache Installation. FIMP ist spleißfertig bestückt und integriert Spleißkamm, Spleißablage, Kupplungen, Pigtails sowie die Kabelverschraubung.

Als Kupplungsvarianten stehen SMA, ST, SC, LC, FC-PC, SC-RJ und E-2000 zur Verfügung. Zum Spleißen lässt sich sowohl die Frontplatte als auch die Spleißkassette vollständig herausnehmen, wobei sich die magnetisierbare Spleißkassette problemlos an einem Spleißgerät fixieren lässt. Für Spleißgeräte mit Dorn ist ein passendes Loch in der Kassette vorgesehen.

Das pulverbeschichtete Edelstahlgehäuse ist ebenfalls magnetisierbar, sodass man den Spleißverteiler an einen Schaltschrank oder ein Gehäuse befestigen kann, falls keine Ablagemöglichkeit vorhanden ist. Darüber hinaus verfügt FIMP über einen Clip zur Montage auf eine 35mm-Hutschiene. Auch ein Kit für die Wandmontage ist erhältlich. Somit ergeben sich für den Anwender bei der Montage der platzsparenden Industrie-Lösung hochgradig flexible Befestigungsmöglichkeiten und Vorteile.

## Industrial Compact Splice Box

With 120mm x 32mm x 120mm, our industrial splice box FIMP-S is by far smaller than comparable 19" solutions. Its inner values are really convincing as well so that the installation is quite simple and done very fast. FIMP is ready for splicing and contains splice tray, couplings, pigtails and cable gland. Regarding different couplings, you can choose from SMA, ST, SC, LC, FC-PC, SC-RJ and E-2000. The front panel and the splice cassette can be removed for splicing and since the cassette is magnetizable, it can easily be fixed onto a splice unit. The cassette has got a hole for splice units with a bolt.

The powder coated stainless steel housing is also magnetizable so that the splice box can easily be affixed to another housing or to a switch cabinet in case of no different tray. Furthermore, FIMP has got a clip for DIN rail mounting (35mm) and optional a kit for wall fastening. Thus, there are space-saving and flexible solutions for mounting our FIMP.





<b>Type MM</b>	6xST Duplex 62MM	6xSC Duplex 62MM	3xLC Quattro 62MM	6xE2000 Duplex 62MM	6xST Duplex 50MM	6xSC Duplex 50MM	3xLC Quattro 50MM	6xE2000 Duplex 50MM	
<b>Order-no.</b>	06300 22196-00	06300 22396-00	06300 22493-00	06300 22596-00	06300 12196-00	06300 12396-00	06300 12493-00	06300 12596-00	
<b>Type SM</b>	6xST Duplex	6xSC Duplex	6xSC 8° APC Duplex	3xLC Quattro	6xE2000 Duplex	6xE2000 8° APC Duplex			
<b>Order-no.</b>	06300 36196-00	06300 36396-00	06300 38396-00	06300 36493-00	06300 36596-00	06300 38596-00			
<b>Weight</b>	380 g								
<b>Dimensions H x W x D</b>	H: 120mm W: 32mm D: 120mm								
<b>Operating temperature</b>	-40°C - +75°C								
<b>Relative humidity</b>	10% - 95% not condensing								
<b>Housing</b>	Stainless steel, powder coated								
<b>Accessories</b>	Order-No.	Description							
	0600E90001	Cable gland M20							
	0600E90002	Locknut M20							
	0600E90003	Strain relief							
	0600E90004	Dummy panel SC duplex							
	0600E90007	Splice holder							
	0600E90008	Splice protection							
	0600E90009	Cable tie							
	0600E90013	Dual Mount Kit							
	0600E90014	Tapping screw (metal)							

0630 0 0 23 0 0 00

Front panel	Type	Fiber type	Coupling / Grinding	Assembly	Number	Colour
0600 SC	0-Standard	0-none	20 50/62,5µm ST/ST - Polymer	0- without, only housing	1 to 6	00 - magenta
0601 E2000 Compact	1-Special	1- MM 50µm	21 50/62,5µm ST/SC - Polymer	1- cable gland etc.		01 - blue
0602 Snap-In		2- MM 62.5µm	23 50/62,5µm SC/SC - Polymer	2- only couplings		
0603 1x Smart-Hole		3- SM 9µm	24 50/62,5µm LC-Quattro	9- complete, couplings+pigtails		
0604 2x Smart-Hole		4- POF	25 50/62,5µm E2000/LowProfile			
		5- HCS	28 50/62,5µm E2000/LAN/LowProfile			
		6- MM 50µm OM3	29 50/62,5µm E2000/LAN/Compact			
			30 50/62,5µm E2000/Compact			
			60 9µm/0° ST/ST/0°			
			61 9µm/0° ST/SC/0°			
			62 9µm/0° ST/SC/0° Metal			
			63 9µm/0° SC/SC/0° - Metal			
			64 9µm/0° LC-Quattro 0°			
			65 9µm/0° E2000/0°/LowProfile			
			70 9µm/0° SC/SC/0° - Polymer (blue)			
			80 9µm/8° ST/ST/8°			
			81 9µm/8° ST/SC/8°			
			83 9µm/8° SC/SC/8° - Metal			
			84 9µm/8° LC-Quattro 8° APC			
			85 9µm/8° E2000/8°/LowProfile			

others on request

# FIMP-XL

## Industrielle Kompakt-Spleißbox

Die „inneren Werte“ des FIMP-XL überzeugen im Hinblick auf eine zeitsparende, einfache Installation. FIMP-XL ist spleißfertig bestückt und integriert Spleißkamm, Spleißablage, Kupplungen, Pigtails sowie die Kabelverschraubung.

Als Kupplungsvarianten stehen SMA, ST, SC, LC, FC-PC, SC-RJ, E-2000 und E-2000 COMPACT zur Verfügung. Zum Spleißen lässt sich sowohl die Frontplatte als auch die Spleißkassette vollständig herausnehmen, wobei sich die magnetisierbare Spleißkassette problemlos an einem Spleißgerät fixieren lässt. Für Spleißgeräte mit Dorn ist ein passendes Loch in der Kassette vorgesehen.

Das pulverbeschichtete Edelstahlgehäuse ist ebenfalls magnetisierbar, sodass man den Spleißverteiler an einen Schaltschrank oder ein Gehäuse befestigen kann, falls keine Ablagemöglichkeit vorhanden ist. Darüber hinaus verfügt FIMP-XL über einen Clip zur Montage auf eine 35mm-Hutschiene. Auch ein Kit für die Wandmontage ist erhältlich. Somit ergeben sich für den Anwender bei der Montage der platzsparenden Industrie-Lösung hochgradig flexible Befestigungsmöglichkeiten und Vorteile.

Zusätzlich können mit FIMPO auch MPO-Verbindungskabel adaptiert werden. Und mit der optionalen aufsteckbaren Schutzhaube werden die Steckverbindungen geschützt.

## Industrial Compact Splice Box

The inner values of the FIMP-XL are really convincing and the installation is quite simple and done very fast. FIMPXL is ready for splicing and it already contains splice tray, couplings, pigtails and cable gland. Regarding different couplings, you can choose from SMA, ST, SC, LC, FC-PC, SC-RJ, E-2000 and E-2000 COMPACT. The front panel and the splice cassette can be removed for splicing and since the cassette is magnetizable, it can easily be fixed onto a splice unit. The cassette has got a hole for splice units with a bolt.

The powder coated stainless steel housing is also magnetizable so that the splice box can easily be affixed to another housing or to a switch cabinet in case of no different tray. Furthermore, FIMP-XL has got a clip for DIN rail mounting (35mm) and a kit for wall fastening. Thus, there are space-saving and flexible solutions for mounting our FIMP-XL.

Additionally fiber optic cables with MPO can be adapted by using FIMPO. And the optional cap protects your fiber and connectors.

The systems are built up modular. Customizing is possible by different assemblies, colors of the housing or logos.

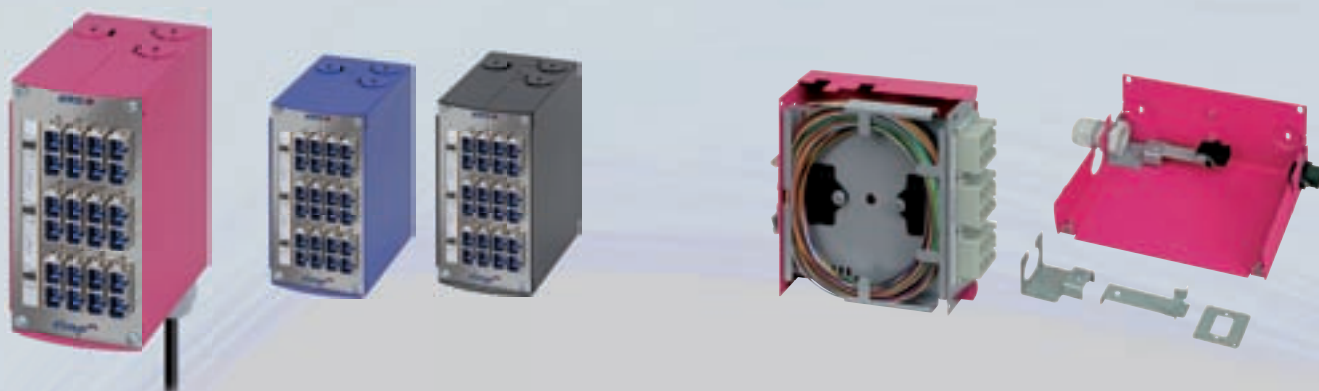

<b>Type MM</b>	<b>12xST Duplex 62MM</b>	<b>12xSC Duplex 62MM</b>	<b>6xLC Quattro 62MM</b>	<b>12xST Duplex 50MM</b>	<b>12xSC Duplex 50MM</b>	<b>6xLC Quattro 50MM</b>			
<b>Order-no.</b>	<b>06100 2206 22069-00</b>	<b>06100 2236 22369-00</b>	<b>06100 2243 22439-00</b>	<b>06100 1216 12169-00</b>	<b>06100 1236 12369-00</b>	<b>06100 1246 00009-00</b>			
<b>Type SM</b>	<b>12xST Duplex SM</b>	<b>12xSC Duplex SM</b>	<b>12xSC 8° APC Duplex SM</b>	<b>6xLC Quattro SM</b>					
<b>Order-no.</b>	<b>06100 3616 36169-00</b>	<b>06100 3706 37069-00</b>	<b>06100 3836 38369-00</b>	<b>06100 3646 00009-00</b>					

<b>Weight</b>	860 g
<b>Dimensions H x W x D</b>	H: 138mm W: 72mm D: 128mm
<b>Operating temperature</b>	-40°C - +75°C
<b>Relative humidity</b>	10% - 95% not condensing
<b>Housing</b>	Stainless steel, powder coated

<b>Accessories</b>	<b>Order-No.</b>	<b>Description</b>
	0600E90001	Cable gland M20
	0600E90002	Locknut M20
	0600E90003	Strain relief
	0600E90004	Dummy panel SC duplex
	0600E90005	Dummy panel Smarthole
	0600E90006	Dummy panel SC-RJ
	0600E90007	Splice holder
	0600E90008	Splice protection
	0600E90009	Cable tie
	0600E90010	Labeling strip
	0600E90011	Screws
	0600E90013	Dual Mount Kit
	0600E90014	Tapping screw (metal)
	0600E90015	Protecting cap
	0600E90016	Mounting angle for protecting cap

0610 0 0 23 0 0 23 0 0 00

Front panel	Type	Fiber type	Couplings / Grinding	Number	Fiber type	Couplings / Grinding	Number	Assembly	Colour
0610 SC	0-Standard	0-none	20 50/62,5µm ST/ST - Polymer	1 to 6	0-none	20 50/62,5µm ST/ST - Polymer	1 to 6	0- without, only housing	00 - magenta
0611 E2000 Compact	1-Special	1- MM 50µm	21 50/62,5µm ST/SC - Polymer		1- MM 50µm	21 50/62,5µm ST/SC - Polymer		1- with cable gland etc.	01 - blue
0612 Snap-In		2- MM 62,5µm	23 50/62,5µm SC/SC - Polymer		2- MM 62,5µm	23 50/62,5µm SC/SC - Polymer		2- only couplings	
0613 1x Smart-Hole		3- SM 9µm	24 50/62,5µm LC-Quattro		3- SM 9µm	24 50/62,5µm LC-Quattro		9- complete, couplings+pigtails	
0614 2x Smart-Hole		4- POF	25 50/62,5µm E2000/LowProfile		4- POF	25 50/62,5µm E2000/LowProfile			
		5- HCS	28 50/62,5µm E2000/LAN/LowProfile		5- HCS	28 50/62,5µm E2000/LAN/LowProfile			
		6- MM 50µm OM3	29 50/62,5µm E2000/LAN/Compact		6- MM 50µm OM3	29 50/62,5µm E2000/LAN/Compact			
			30 50/62,5µm E2000/Compact			30 50/62,5µm E2000/Compact			
			60 9µm/0° ST/ST/0°			60 9µm/0° ST/ST/0°			
			61 9µm/0° ST/SC/0°			61 9µm/0° ST/SC/0°			
			62 9µm/0° ST/SC/0° Metal			62 9µm/0° ST/SC/0° Metal			
			63 9µm/0° SC/SC/0° - Metal			63 9µm/0° SC/SC/0° - Metal			
			64 9µm/0° LC-Quattro 0°			64 9µm/0° LC-Quattro 0°			
			65 9µm/0° E2000/0°/LowProfile			65 9µm/0° E2000/0°/LowProfile			
			70 9µm/0° SC/SC/0° - Polymer (blue)			70 9µm/0° SC/SC/0° - Polymer (blue)			
			80 9µm/8° ST/ST/8°			80 9µm/8° ST/ST/8°			
			81 9µm/8° ST/SC/8°			81 9µm/8° ST/SC/8°			
			83 9µm/8° SC/SC/8° - Metal			83 9µm/8° SC/SC/8° - Metal			
			84 9µm/8° LC-Quattro 8° APC			84 9µm/8° LC-Quattro 8° APC			
			85 9µm/8° E2000/8°/LowProfile			85 9µm/8° E2000/8°/LowProfile			

others on request

**Couplings left side**  
(MM with MIX-Systems)

**Couplings right side**  
(SM with MIX-Systems)

# FIMP-XL Hybrid

## Industrielle Kompakt-Spleißbox und Patchpanel

FIMP-XL Hybrid vereint Kupfer und Glasfaser in einem Modul: Modulares industrielles Patchpanel/Spleißbox für bis zu 12 Glasfasern, und 6 x RJ45 CAT 6A Buchsen für Netzwerk-Stecker.

FIMP-XL Hybrid ist spleißfertig bestückt und integriert Spleißkamm, Spleißablage, Kupplungen, Pigtails sowie die Kabelverschraubung.

Als Kupplungsvarianten stehen SMA, ST, SC, LC, FC-PC, SC-RJ, E-2000 und E-2000 COMPACT zur Verfügung. Zum Spleißen lässt sich sowohl die Frontplatte als auch die Spleißkassette vollständig herausnehmen, wobei sich die magnetisierbare Spleißkassette problemlos an einem Spleißgerät fixieren lässt. Für Spleißgeräte mit Dorn ist ein passendes Loch in der Kassette vorgesehen.

Das pulverbeschichtete Edelstahlgehäuse ist ebenfalls magnetisierbar, sodass man den Spleißverteiler an einen Schaltschrank oder ein Gehäuse befestigen kann, falls keine Ablagemöglichkeit vorhanden ist. Darüber hinaus verfügt FIMP-XL Hybrid über einen Clip zur Montage auf eine 35mm-Hutschiene. Auch ein Kit für die Wandmontage ist erhältlich. Somit ergeben sich für den Anwender bei der Montage der platzsparenden Industrie-Lösung hochgradig flexible Befestigungsmöglichkeiten und Vorteile.

Zusätzlich können mit FIMPO auch MPO-Verbindungskabel adaptiert werden. Und mit der optionalen aufsteckbaren Schutzhaube werden die Steckverbindungen geschützt.

## Industrial Compact Splice Box and Patchpanel

FIMP-XL Hybrid combines two different worlds: Glass fiber and copper cables. It provides a high level of flexibility for your application since it has optical connectors for up to 12 fibers and 6 RJ45 connectors for network cables.

FIMP-XL Hybrid is ready for splicing and it already contains splice tray, couplings, pigtails and cable gland. Regarding different couplings, you can choose from SMA, ST, SC, LC, FC-PC, SC-RJ, E-2000 and E-2000 COMPACT. The front panel and the splice cassette can be removed for splicing and since the cassette is magnetizable, it can easily be fixed onto a splice unit. The cassette has got a hole for splice units with a bolt.

The powder coated stainless steel housing is also magnetizable so that the splice box can easily be affixed to another housing or to a switch cabinet in case of no different tray. Furthermore, FIMP-XL Hybrid has got a clip for DIN rail mounting (35mm) and a kit for wall fastening. Thus, there are space-saving and flexible solutions for mounting our FIMP-XL Hybrid.

Additionally fiber optic cables with MPO can be adapted by using FIMPO. And the optional cap protects your fiber and connectors.

The systems are built up modular. Customizing is possible by different assemblies, colors of the housing or logos.





# RACK 19

## Universal Hutschienenträger

Das Rack 19" kann für die Aufnahme von Hutschienengehäuse je nach Anwendung vorab vertikal oder horizontal montiert werden. Es ist auch zur Verwendung von Wand- und Deckenmontage geeignet. Die Aufnahme mit der Hutschchiene kann in der Tiefe verstellt werden. Die Winkel sind in 3 Ausführungen für die 19" Montage erhältlich. Diese dienen zur Anpassung der Höhe (HE Einheit) und können auch im eingebauten System verstellt werden.

## Universal DIN Rail Rack

Rack 19" can be used for the mounting of a DIN rail in a horizontal or vertical way. Furthermore, it is suitable for wall mount or ceiling suspension. The DIN rail can be adjusted in depth. There are 3 different angles for 19" mount. They are used for adjusting the height and can be changed even if they are mounted.



<b>Type</b>	<b>Rack 19" Universal-Hutschienenträger</b>	
<b>Order-no.</b>	0600E90050	
<b>Dimensions H x W x D</b>	H: 88,1 mm W: 482,6mm D: 210mm	
<b>Operating temperature</b>	-40°C - +75°C	
<b>Relative humidity</b>	10% - 95% not condensing	
<b>Housing material</b>	Aluminium-zinc	
<b>Accessories</b>	Order-No.	Description
	0600E90051	3HE Mounting Kit / Stainless Steel
	0600E90052	4HE Mounting Kit / Stainless Steel
	0600E90053	5HE Mounting Kit / Stainless Steel



#### Headquarter

eks Engel GmbH & Co. KG  
Schützenstraße 2-4 · D-57482 Wenden  
GERMANY  
Fon +49 (0) 2762 9313-600  
Fax +49 (0) 2762 9313-7906  
info@eks-engel.de  
www.eks-engel.de

#### North America

eks Fiber Optics LP  
150 N Michigan Ave, Suite 2818 · Chicago, IL 60601  
USA  
Phone +1 (312) 291-4482  
info@eks-fo.com  
www.eks-fo.com

#### Distributor



**fiber optic systems**